

Diseños

Designs

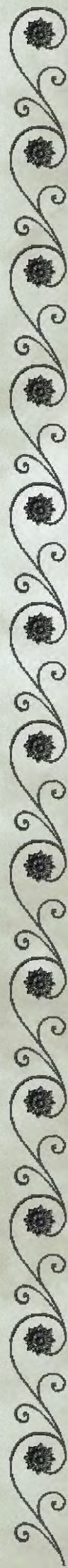



Adjuntamos una pequeña muestra de las múltiples combinaciones que pueden hacerse con nuestros diseños. Les proponemos que pongan o quiten, recarguen o simplifiquen, o, por ejemplo, monten una cancela con la combinación de diseños propuestos en una reja.

Les aconsejamos que encarguen la fabricación de su diseño a un profesional, que además les darán mil y una ideas para conseguir “ese” que usted quiere.

ESCALERAS / STAIRCASES

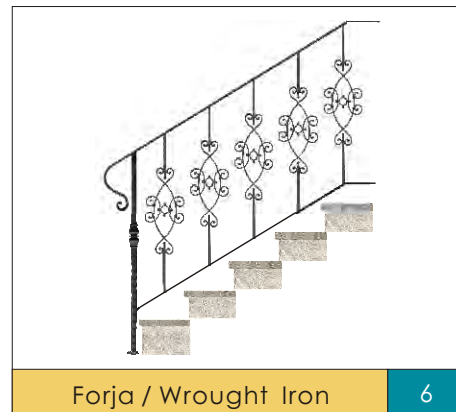
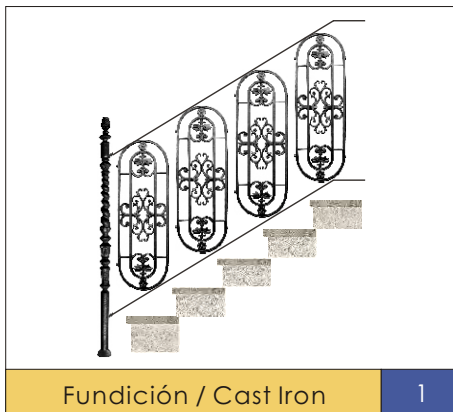

BALCÓNES / BALCONIES

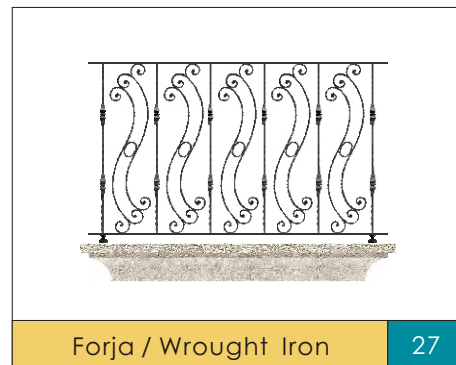

REJAS / BARS OF WINDOWS



NOTA: Las referencias que empiezan por la letra “ F ” son piezas que encontrará en la pestaña “ FORJA ” .

BARANDAS / RAILINGS

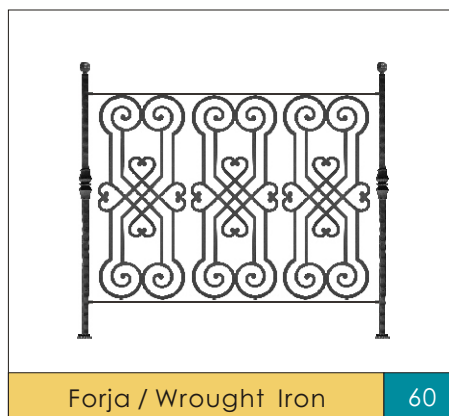

VALLAS / FENCES



CANCELAS / GATES

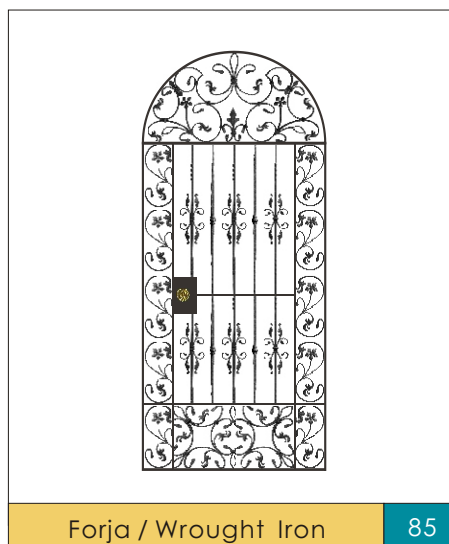
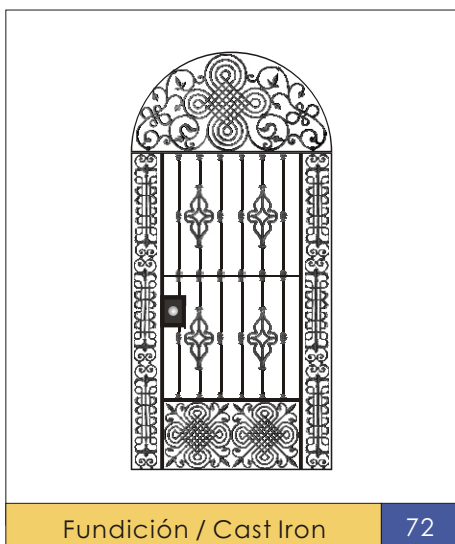



ESCALERAS / FUNDICIÓN

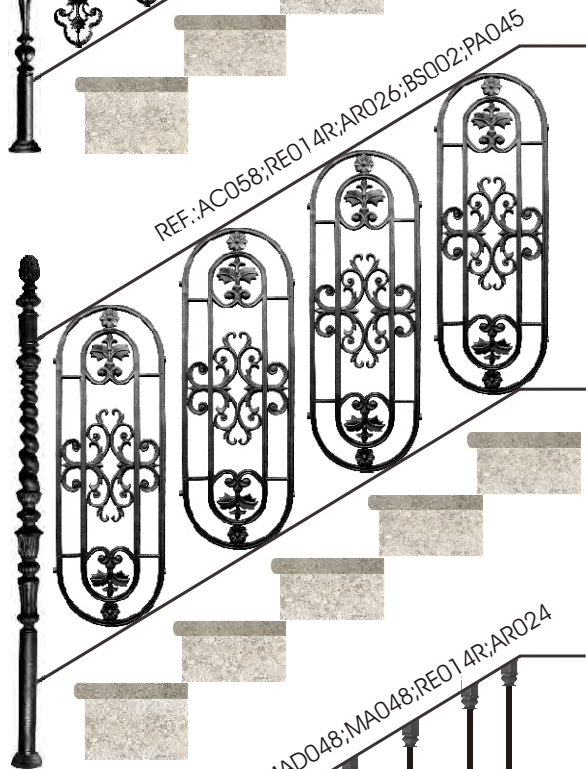
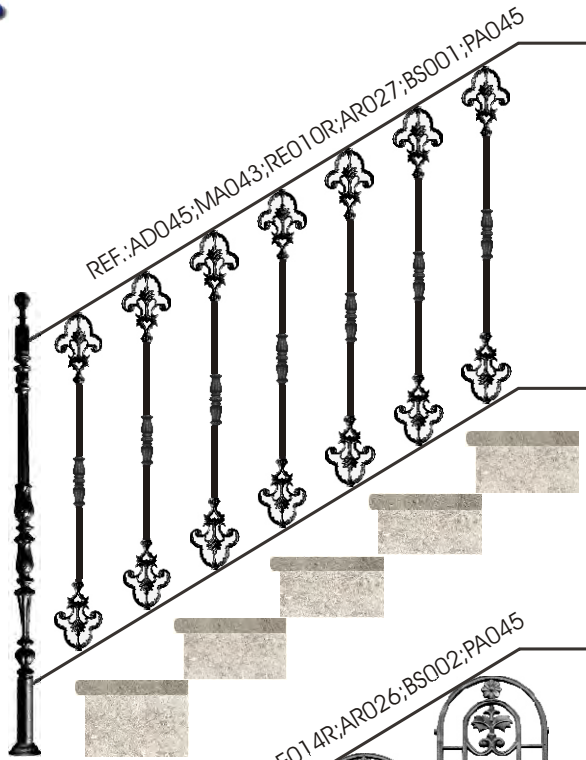

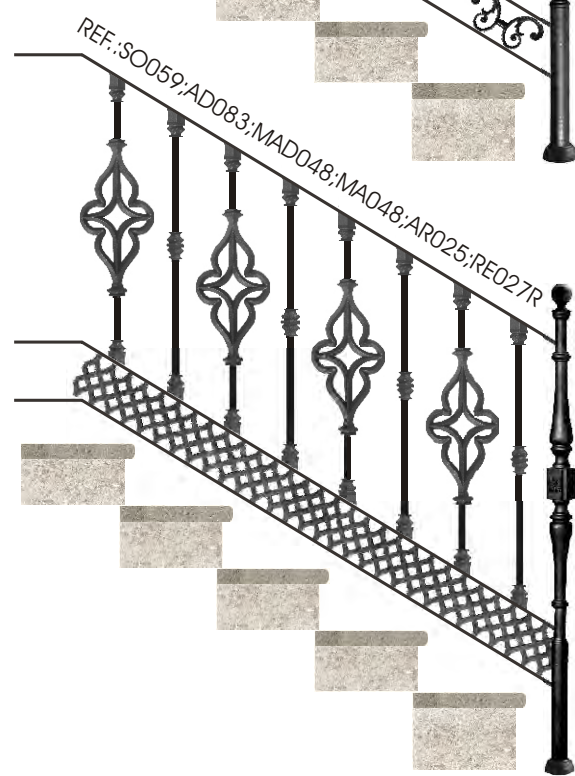
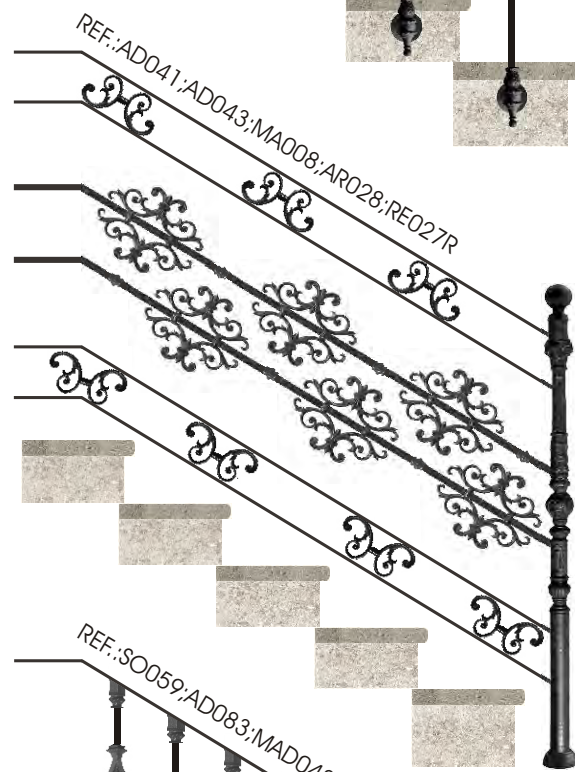
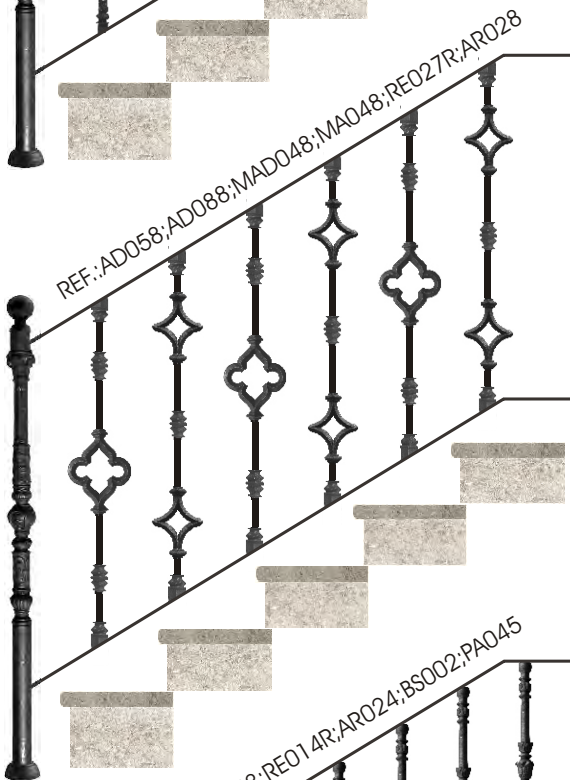
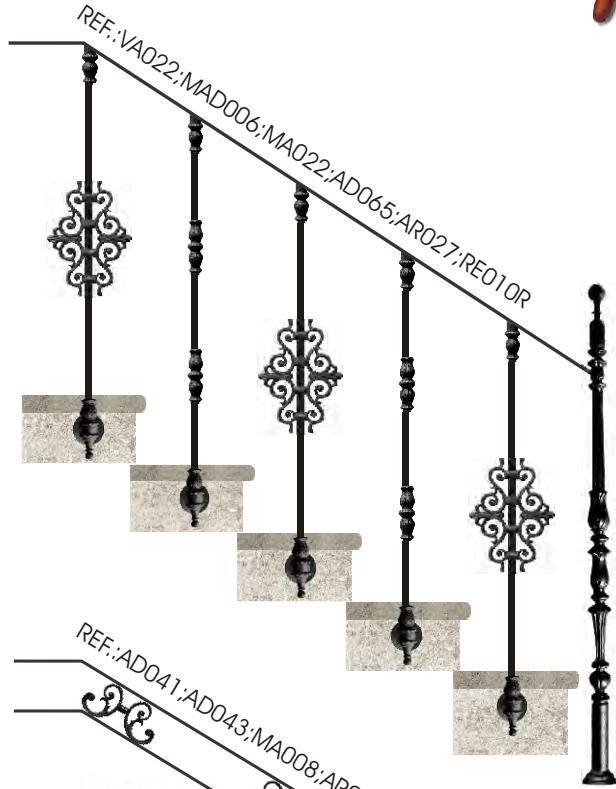



ESCALERAS / FUNDICIÓN

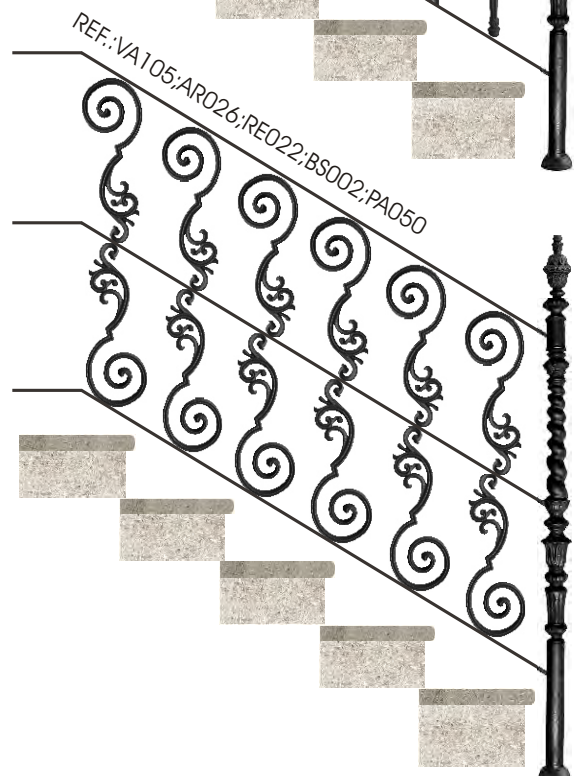
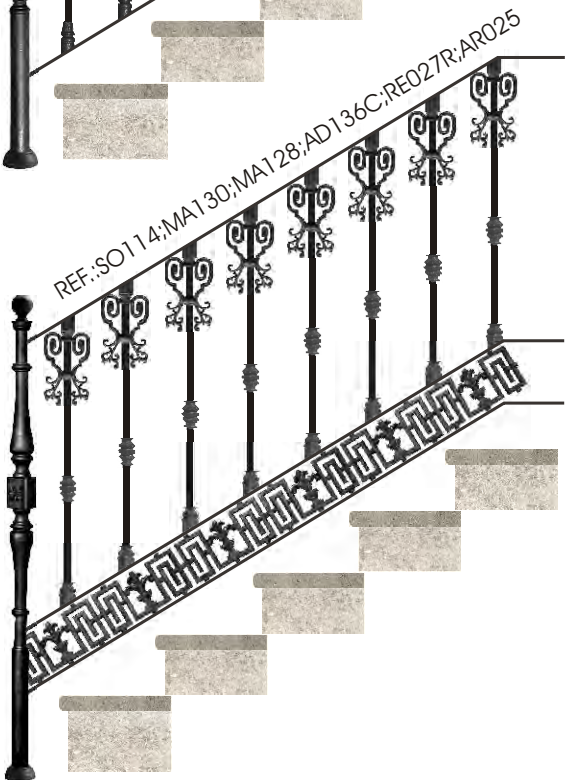
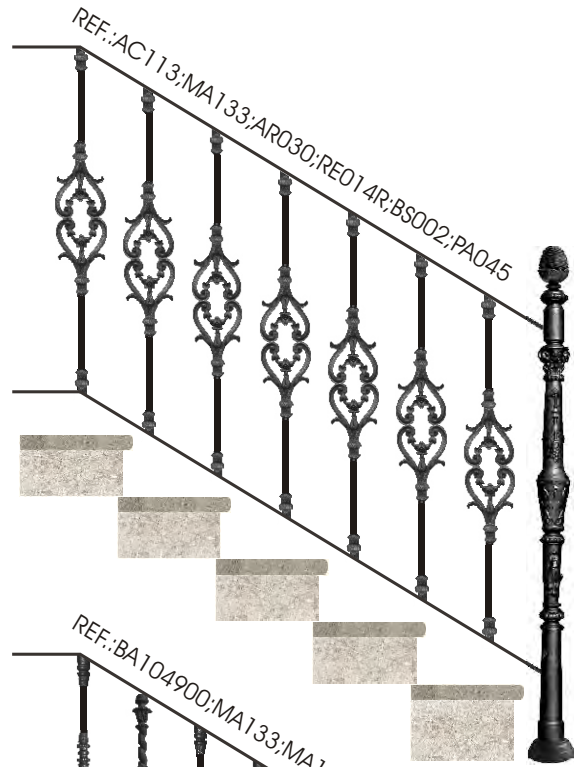
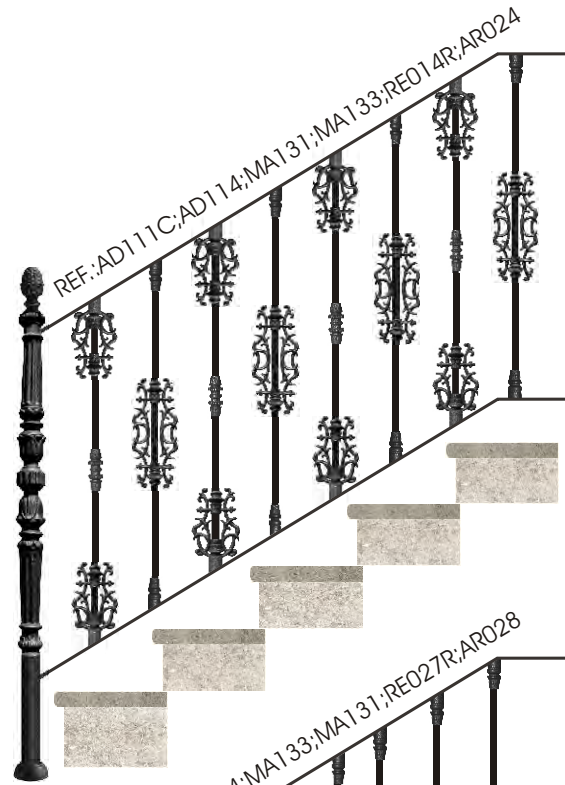

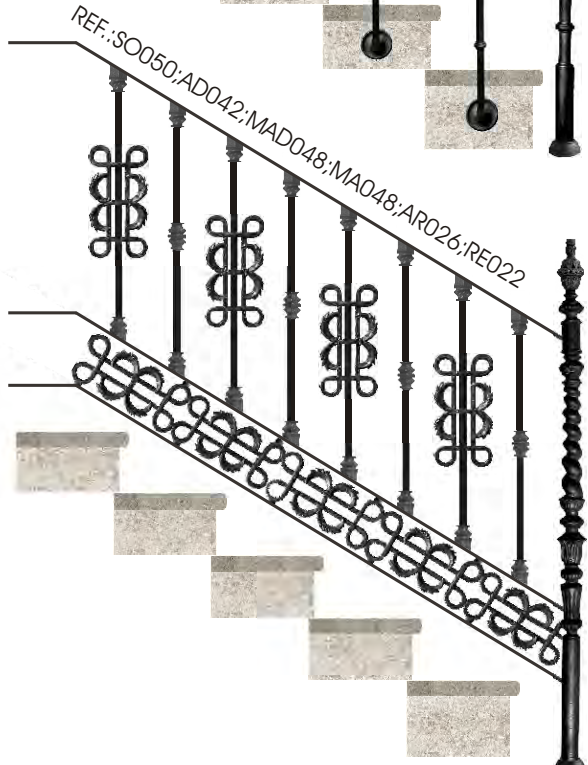
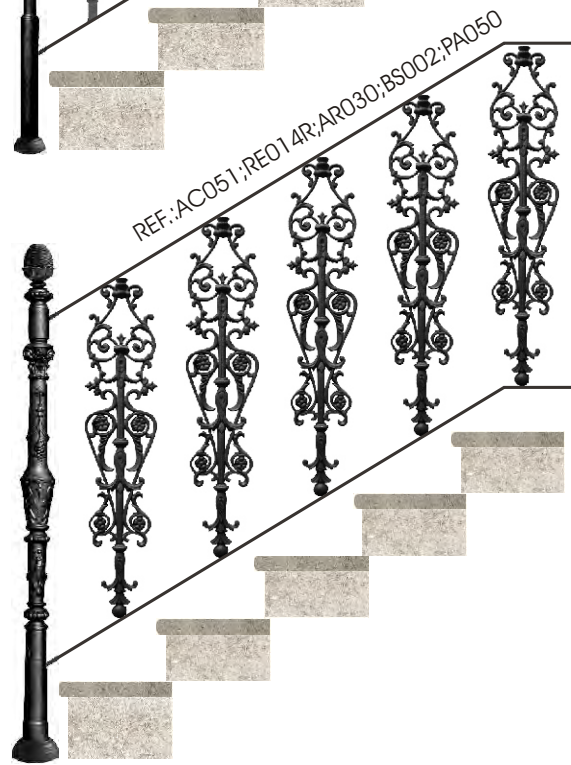
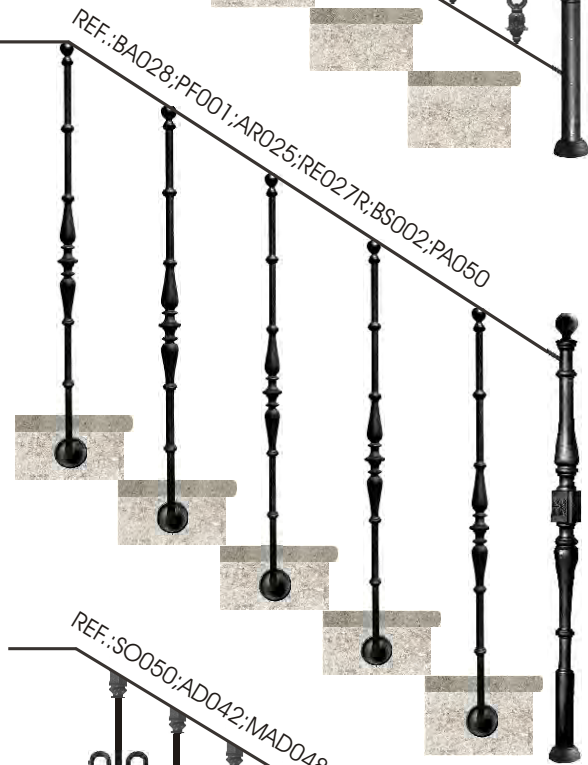
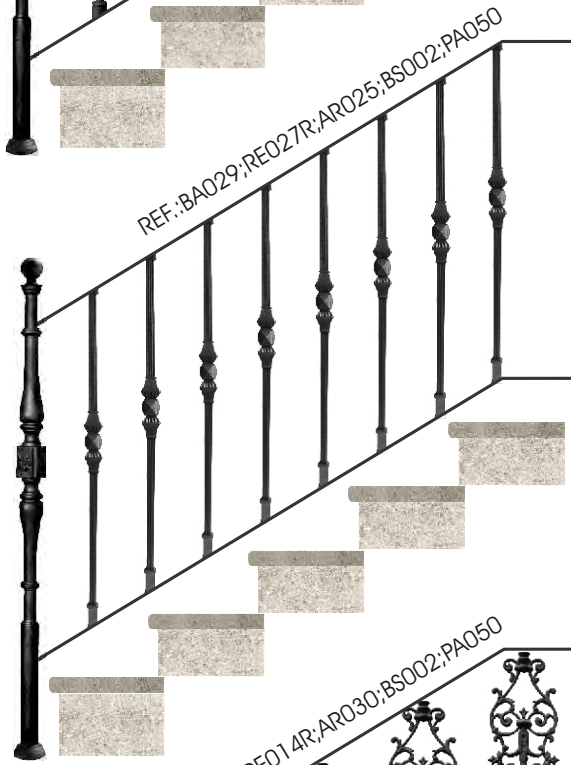
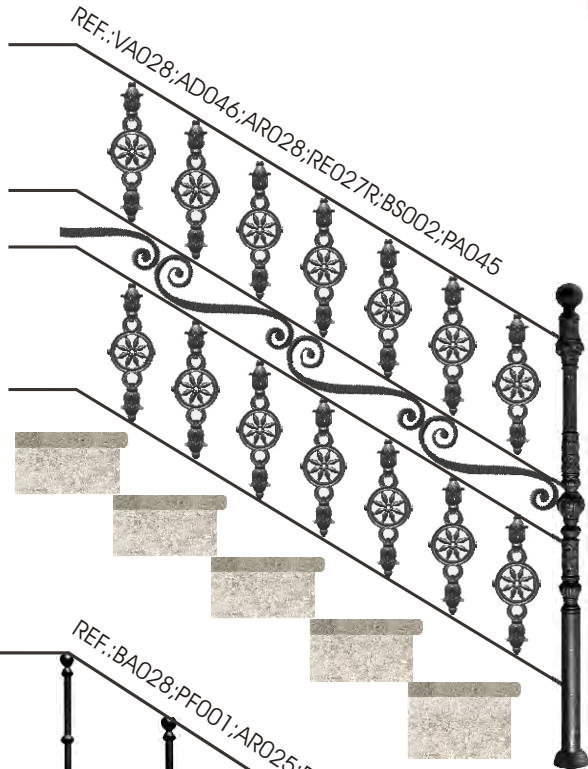
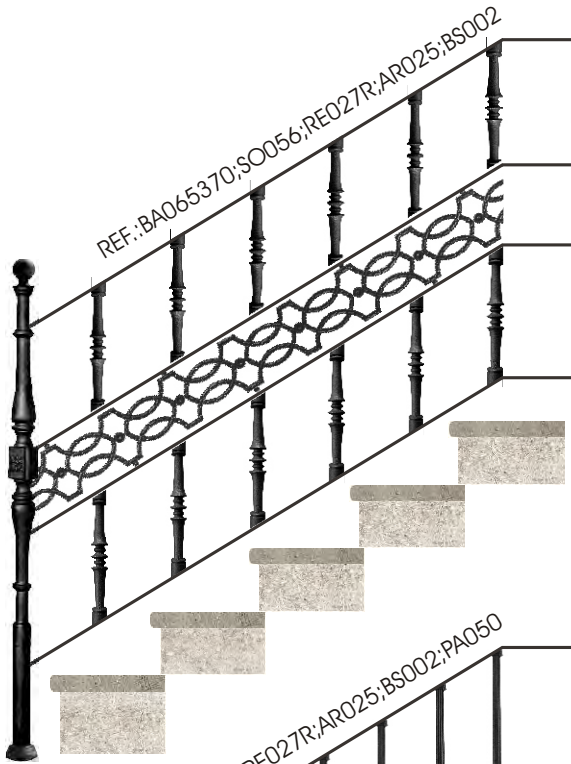



ESCALERAS / FUNDICIÓN

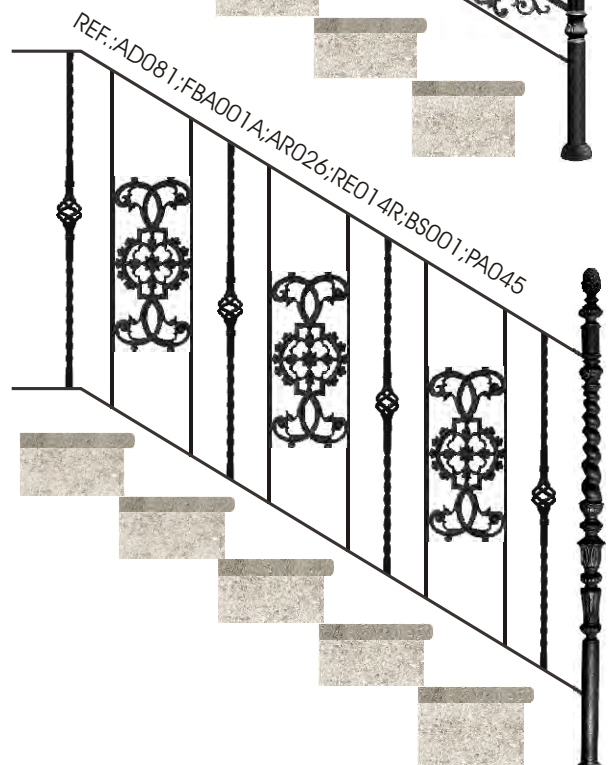
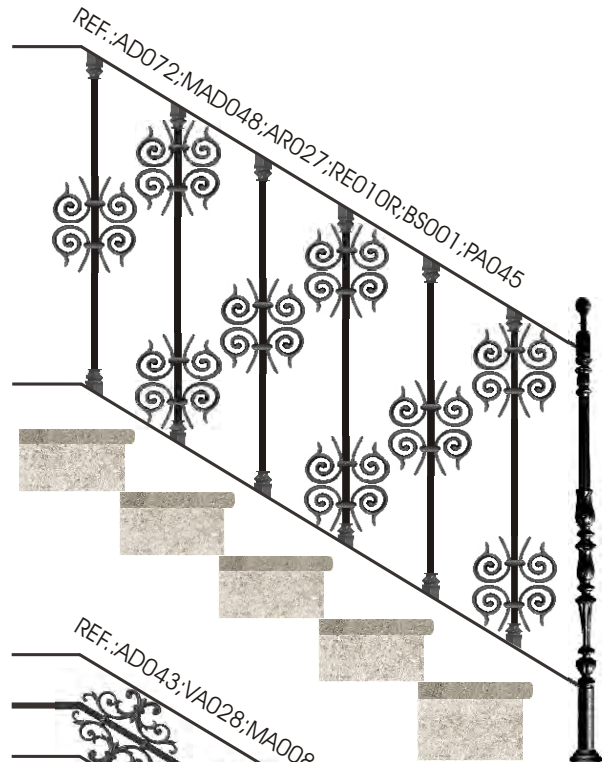
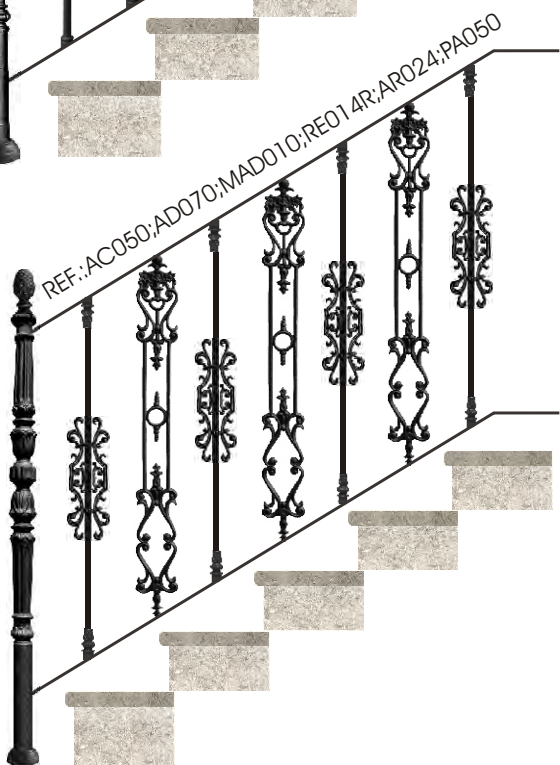
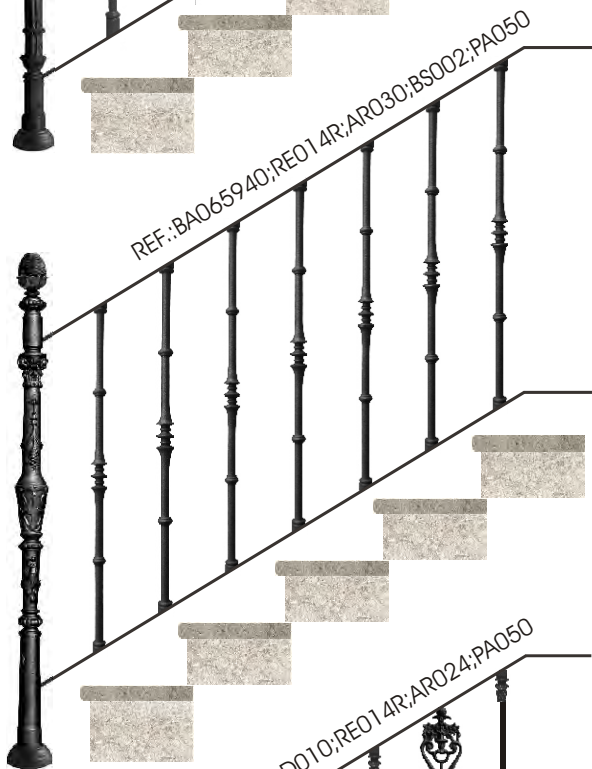
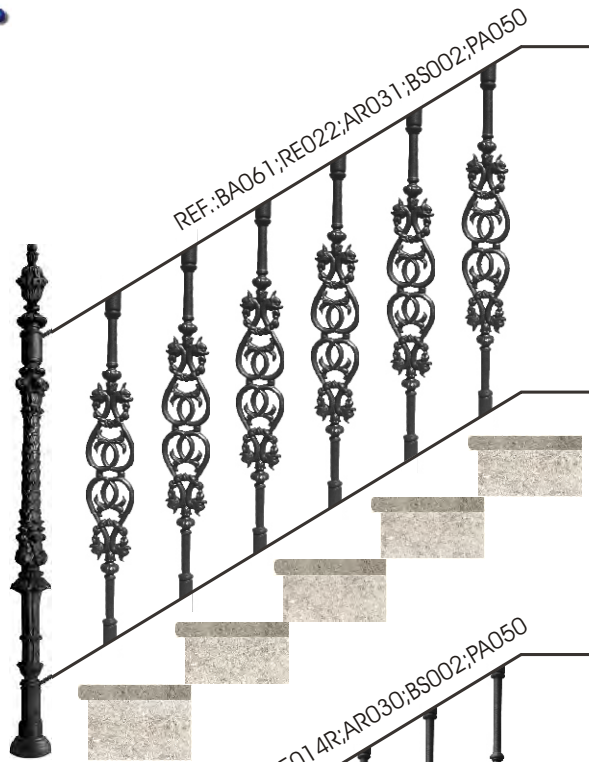

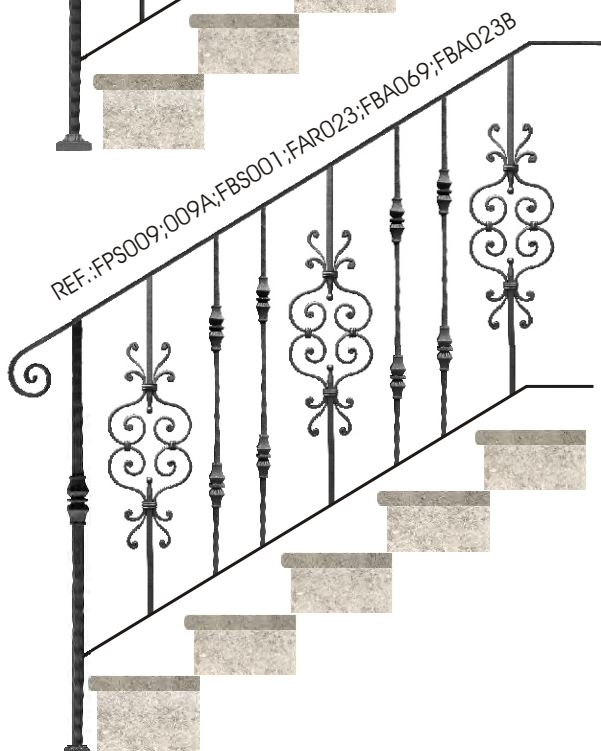
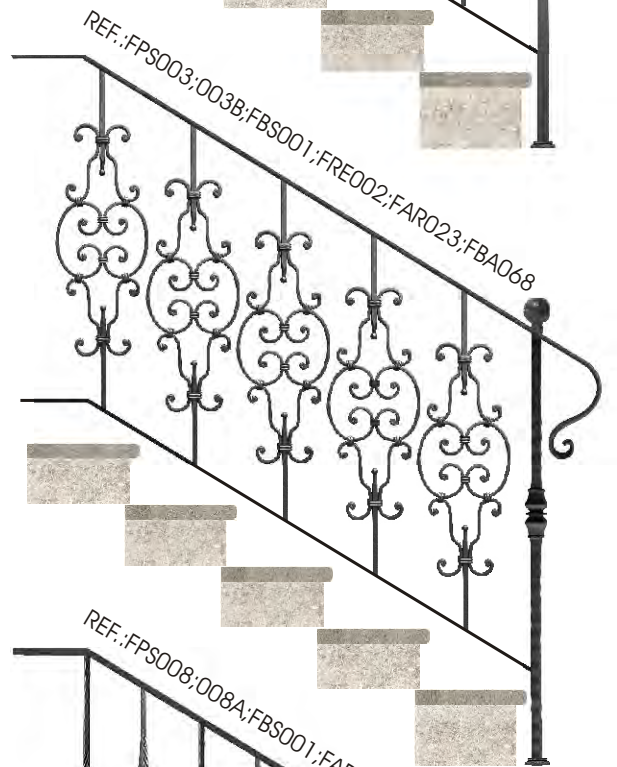
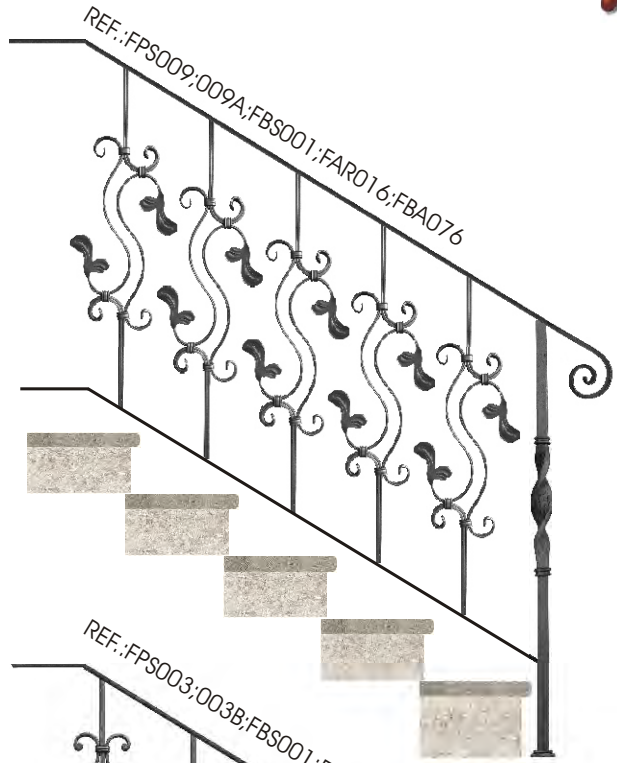
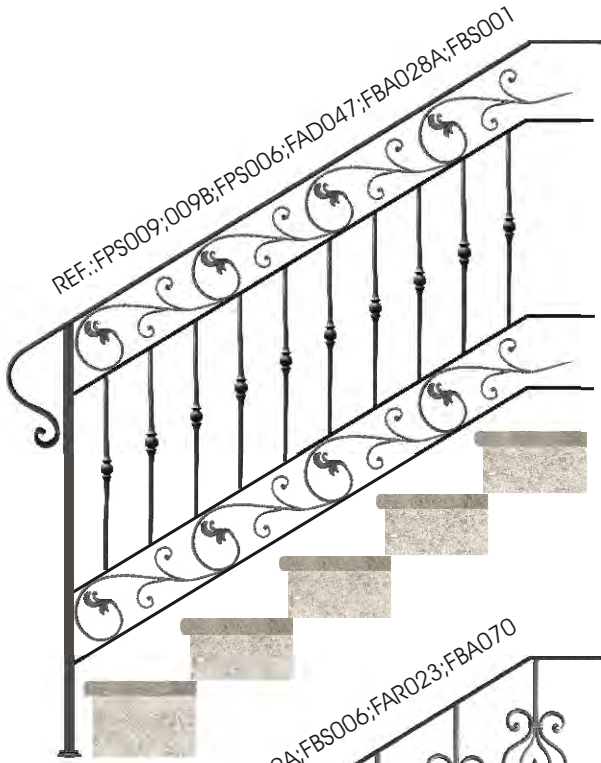

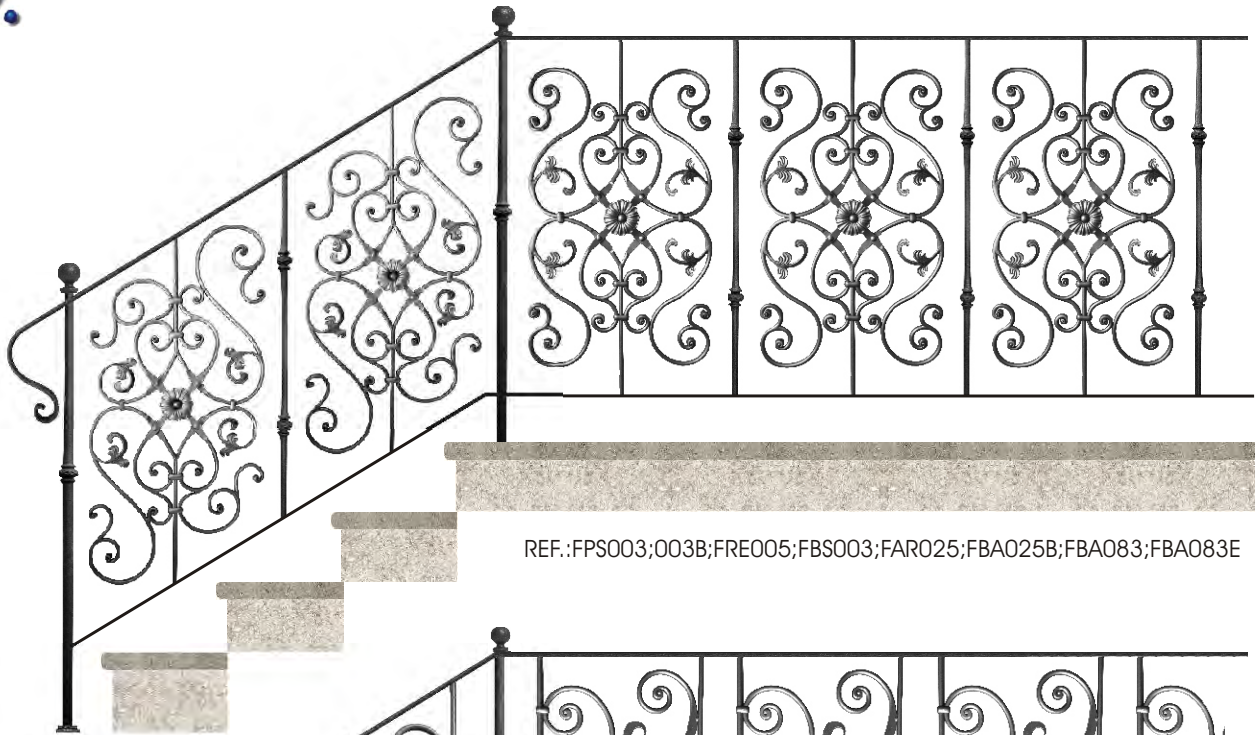

REF.:FPS003;003B;FRE005;FBS003;FAR025;FBA025B;FBA083;FBA083E



REF.:FPS003;003B;FRE005;FBS003;FAR022;FBA084;FBA084E

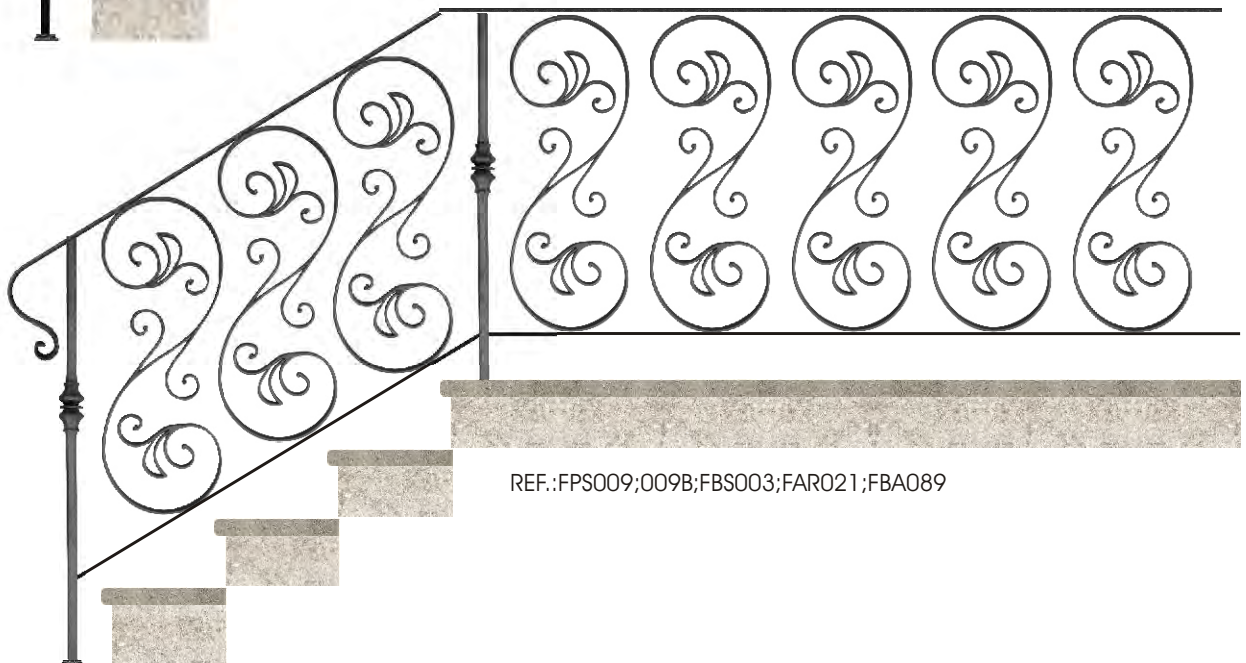

REF.:FPS009;009B;FBS003;FAR021;FBA089

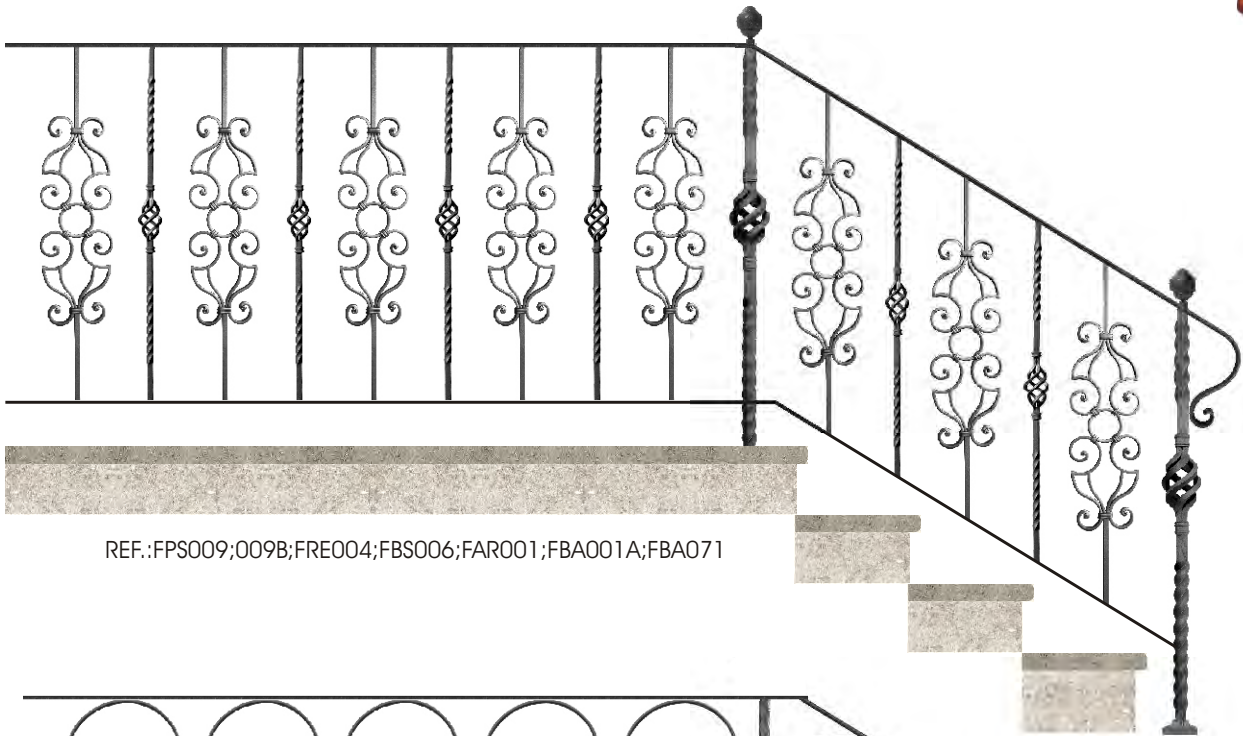

REF.:FPS009;009B;FRE004;FBS006;FAR001;FBA001A;FBA071

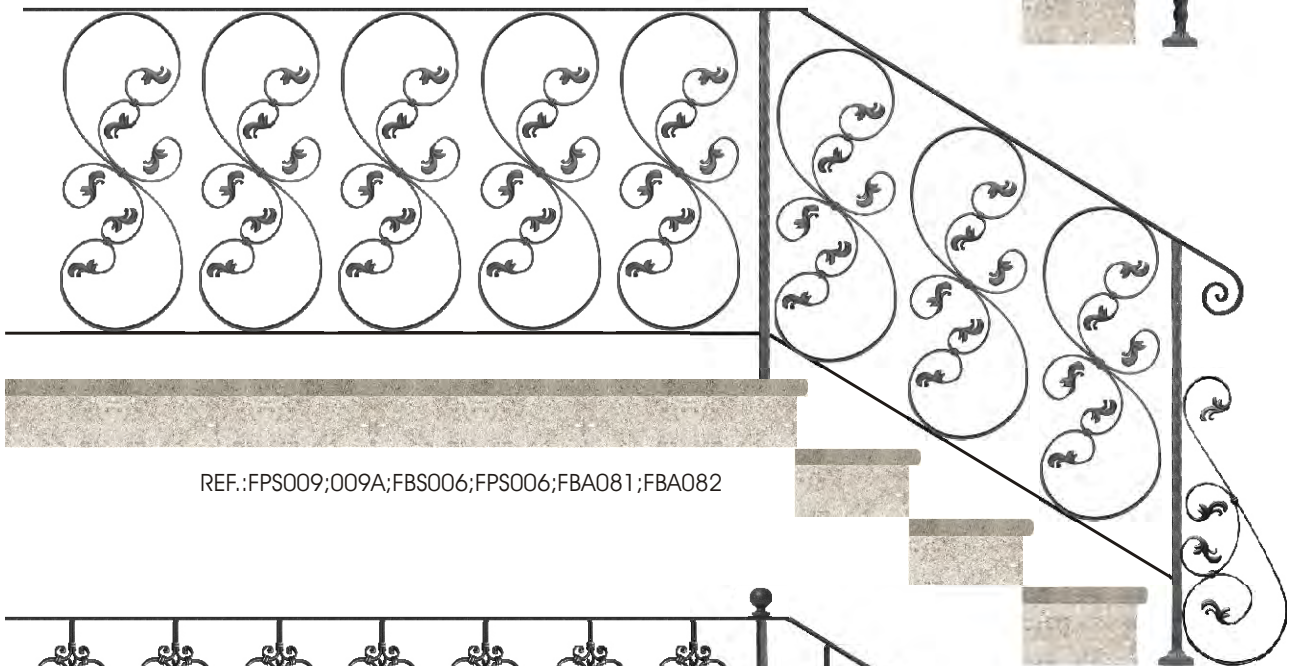

REF.:FPS009;009A;FBS006;FPS006;FBA081;FBA082

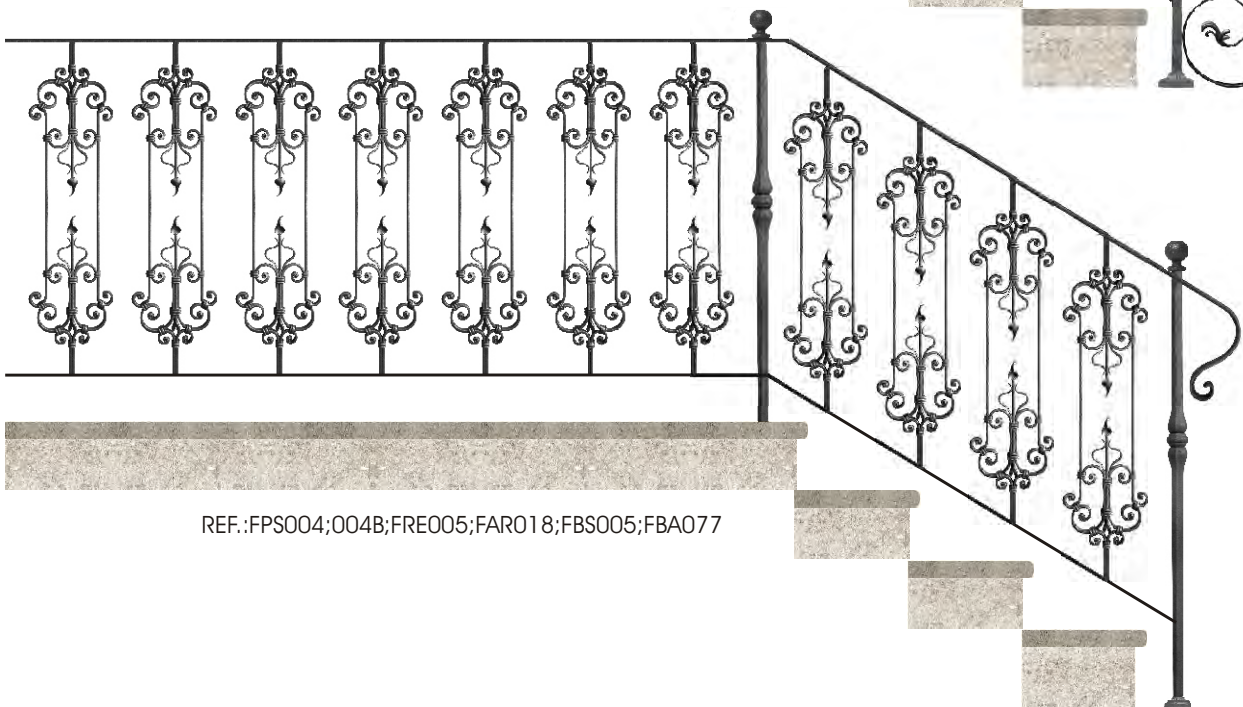

REF.:FPS004;004B;FRE005;FAR018;FBS005;FBA077

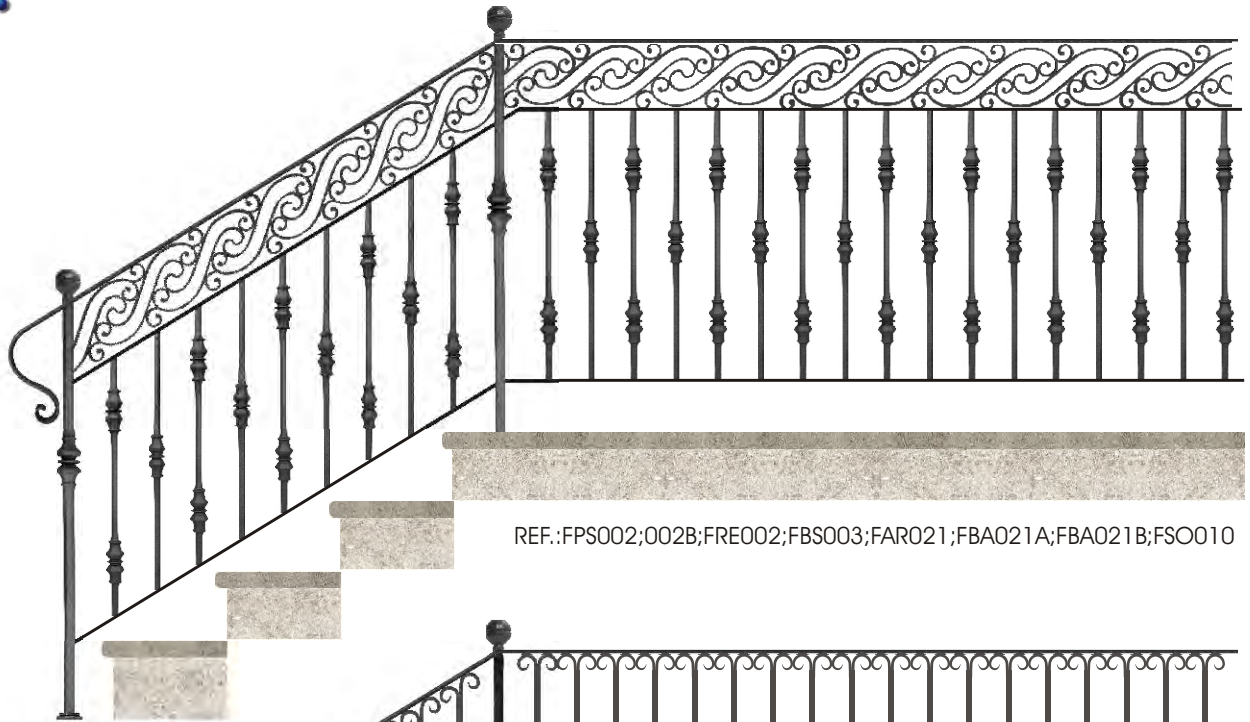

REF.:FPS002;002B;FRE002;FBS003;FAR021;FBA021A;FBA021B;FSO010

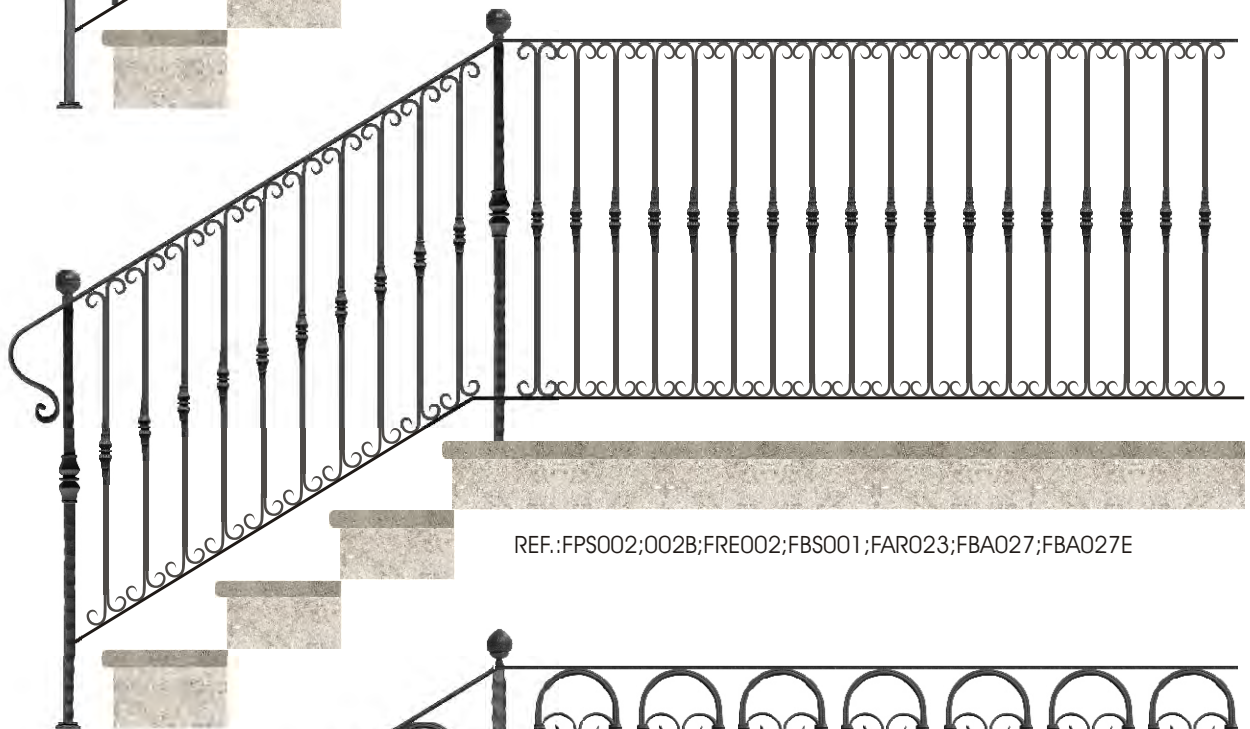

REF.:FPS002;002B;FRE002;FBS001;FAR023;FBA027;FBA027E

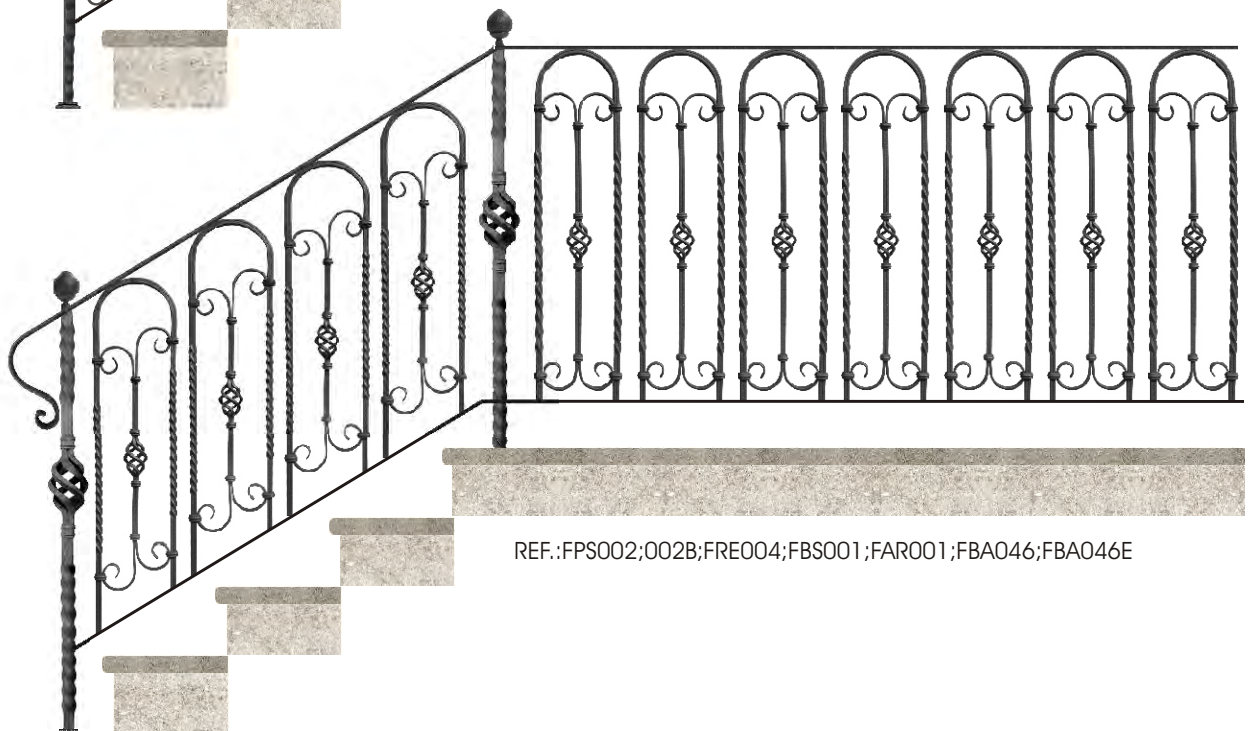

REF.:FPS002;002B;FRE004;FBS001;FAR001;FBA046;FBA046E

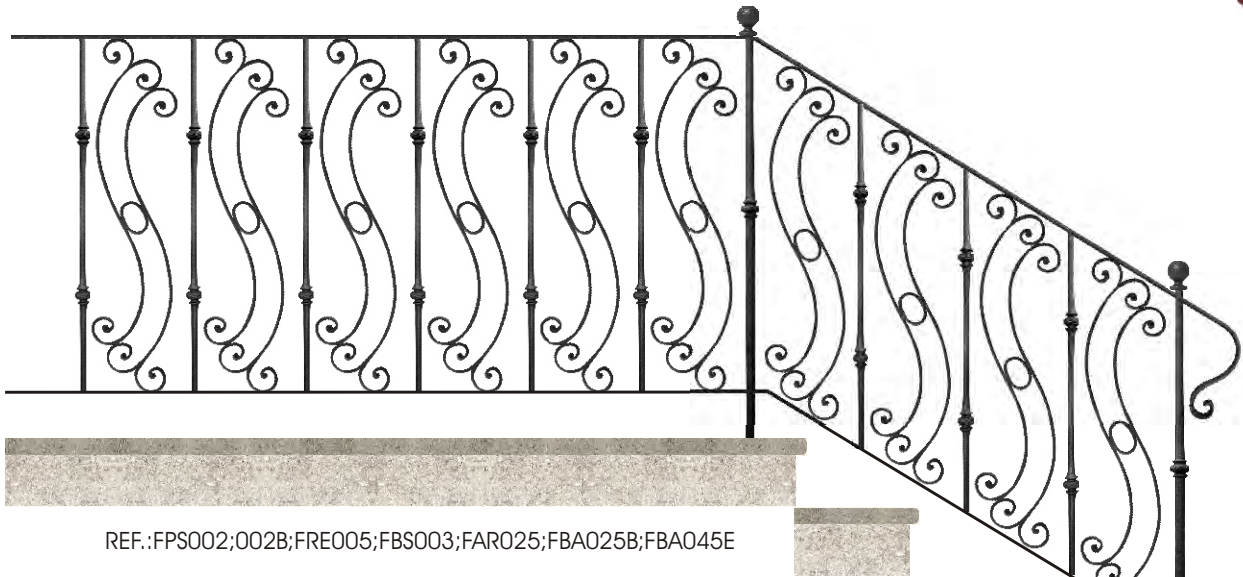

REF.:FPS002;002B;FRE005;FBS003;FAR025;FBA025B;FBA045E

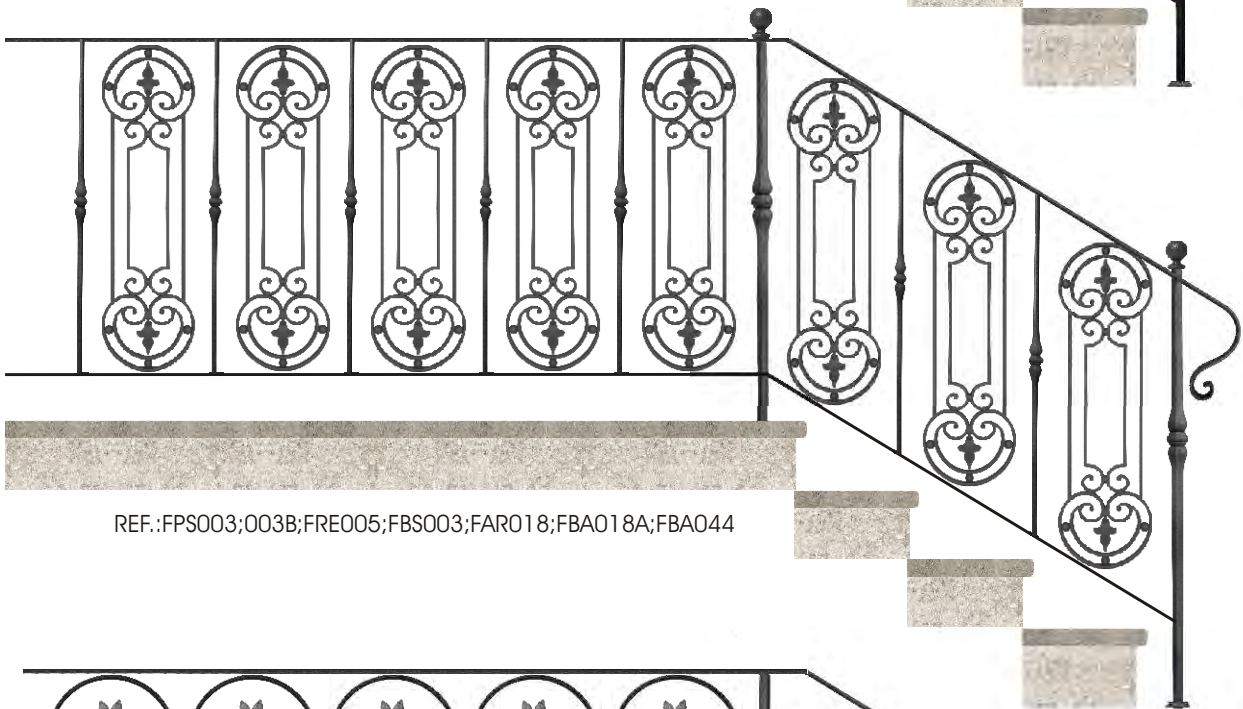

REF.:FPS003;003B;FRE005;FBS003;FAR018;FBA018A;FBA044

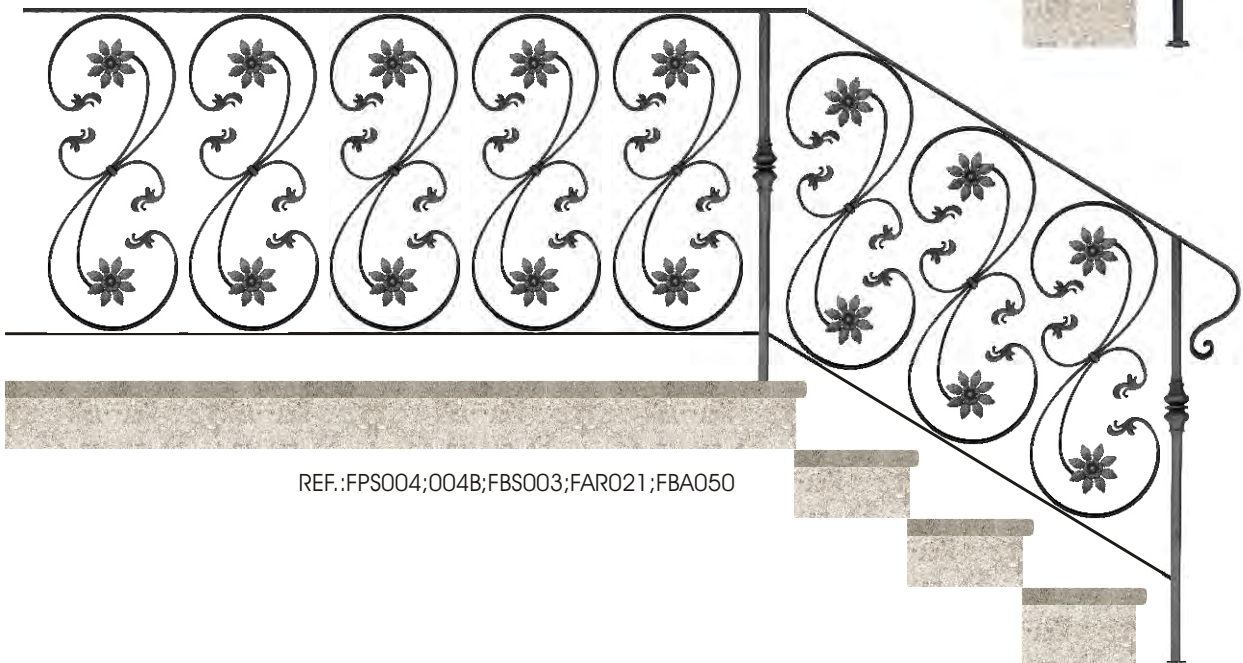

REF.:FPS004;004B;FBS003;FAR021;FBA050



ESCALERAS / FORJA

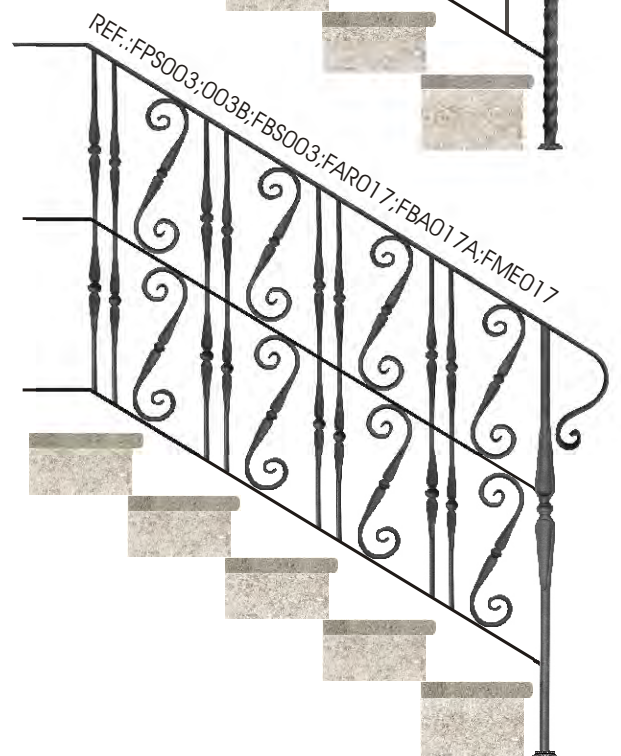
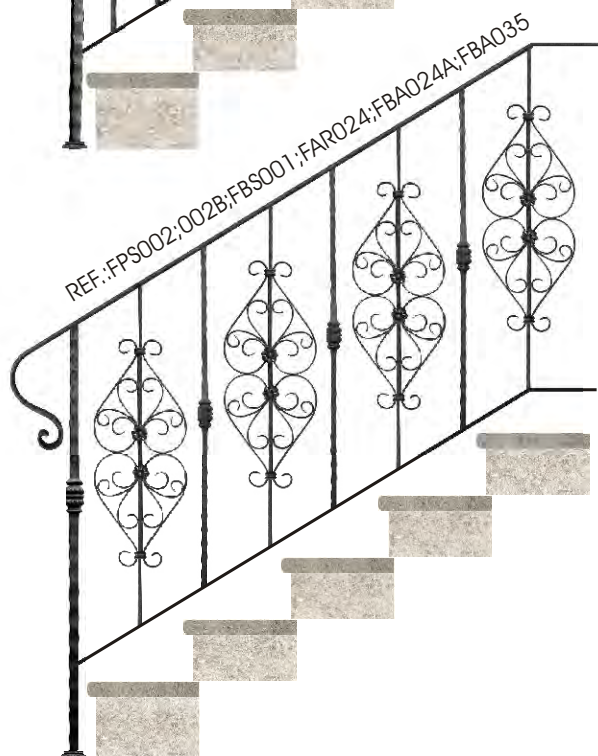
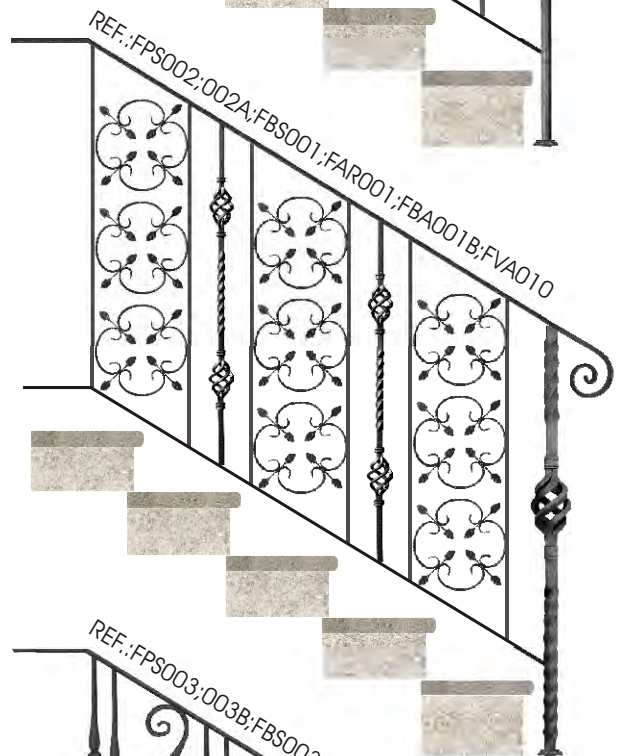
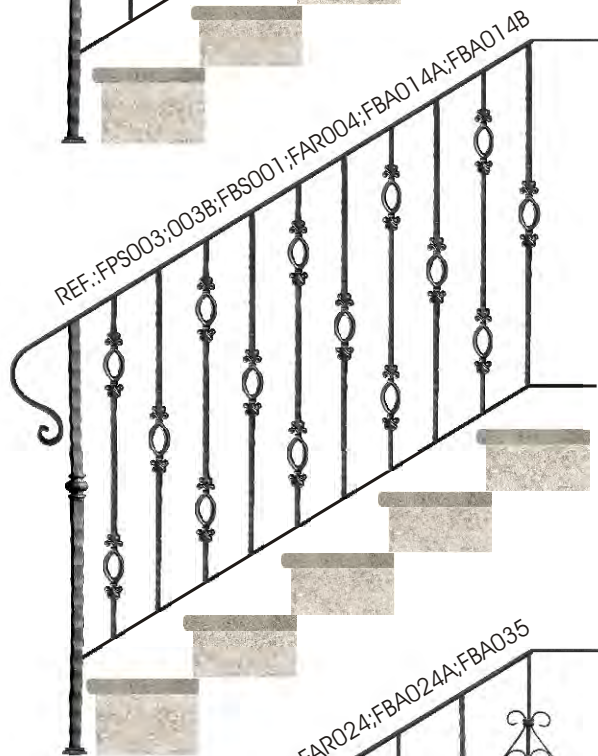
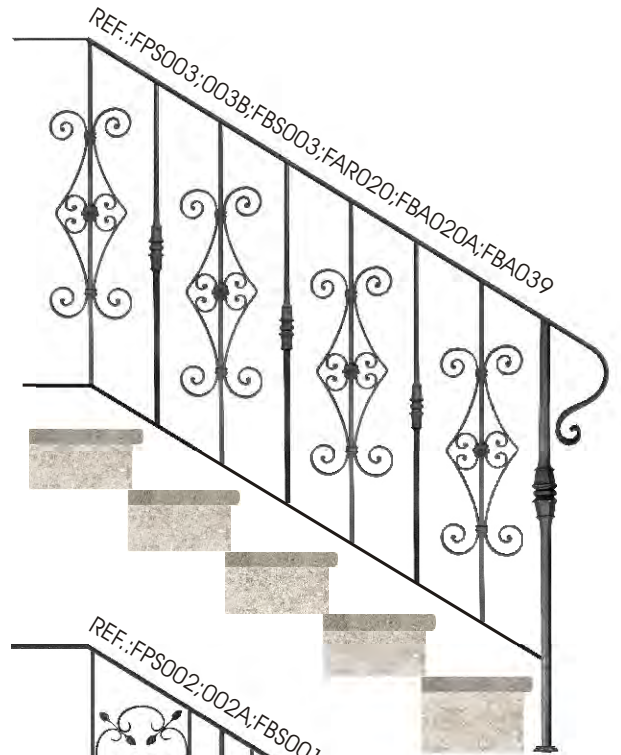
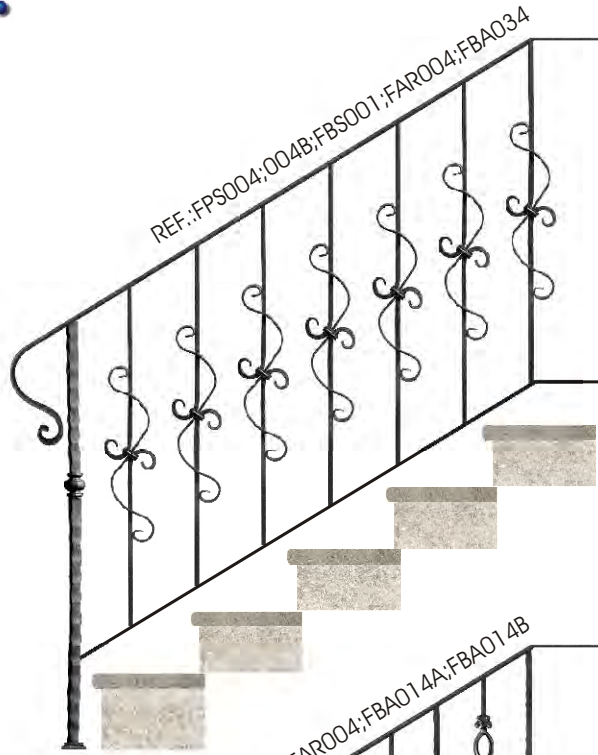

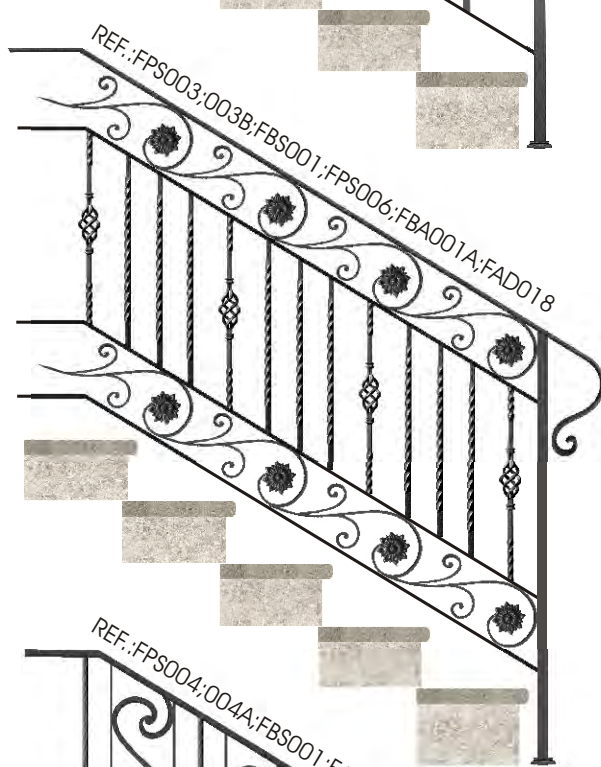
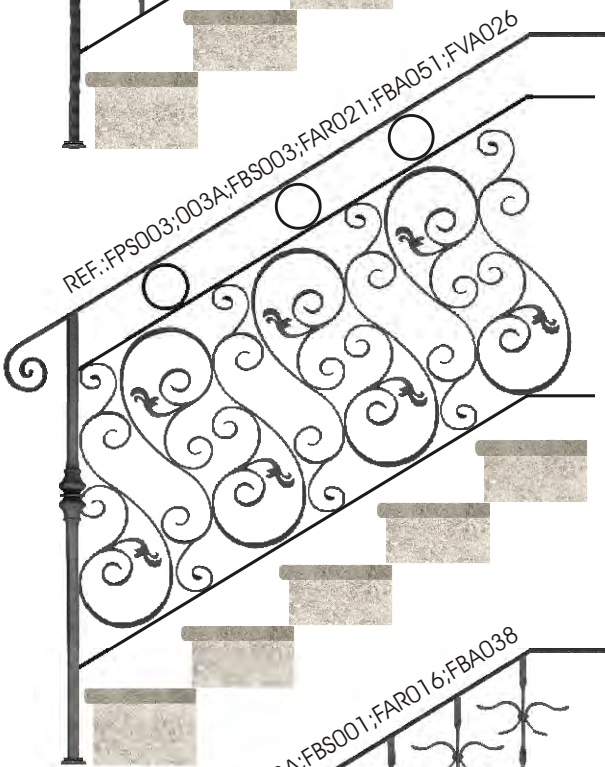
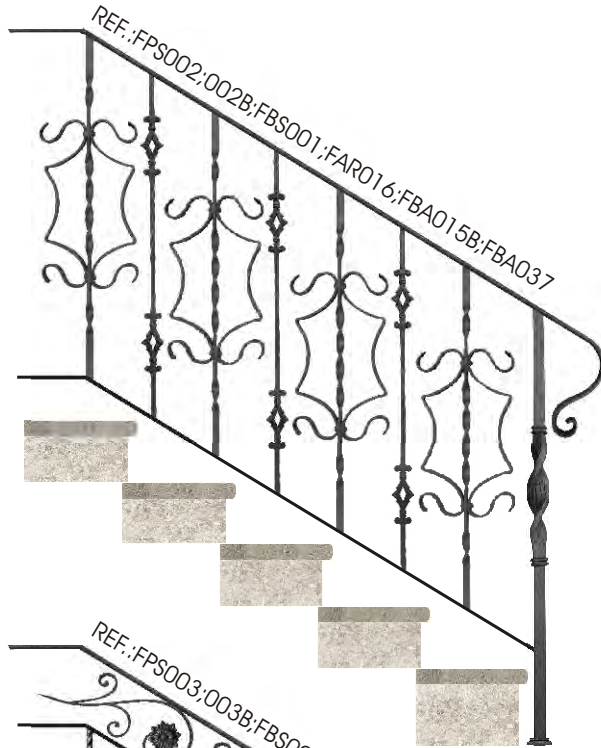
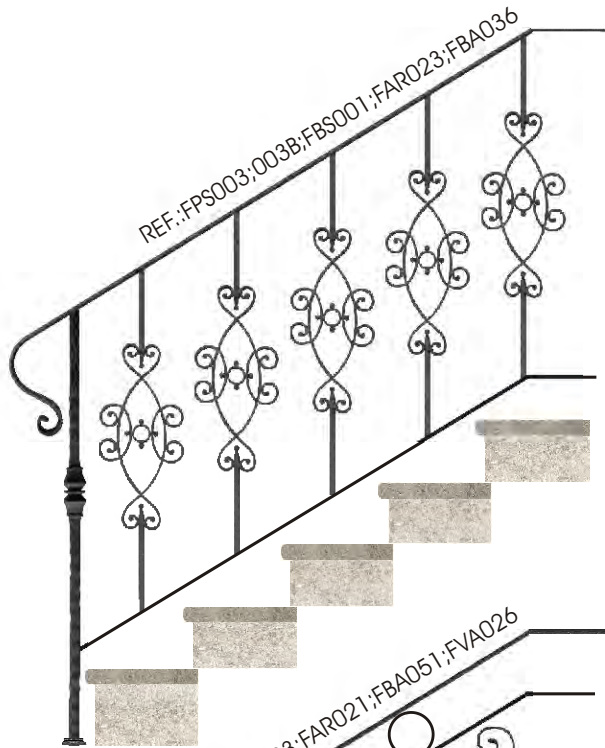



ESCALERAS / FORJA

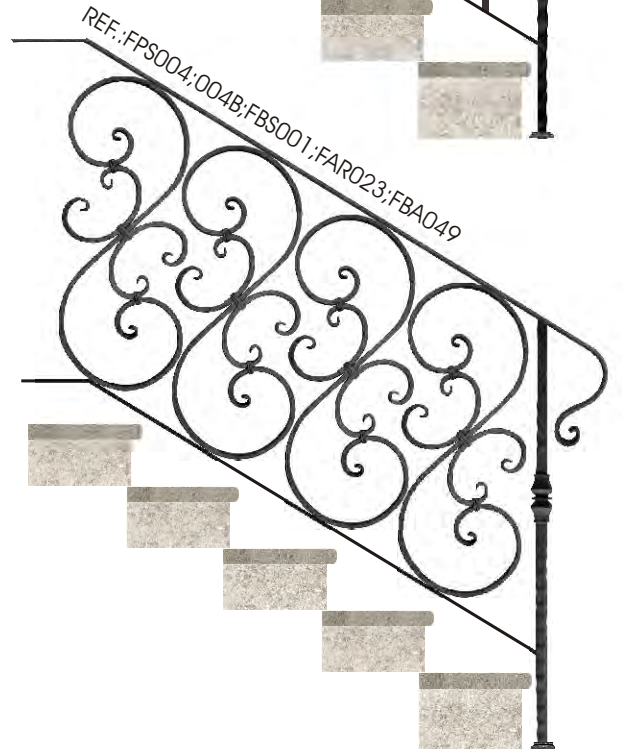
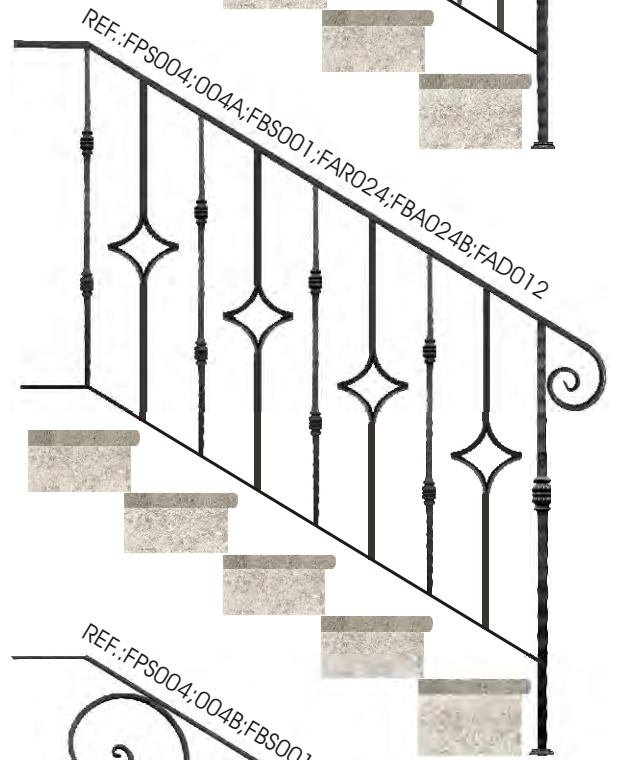
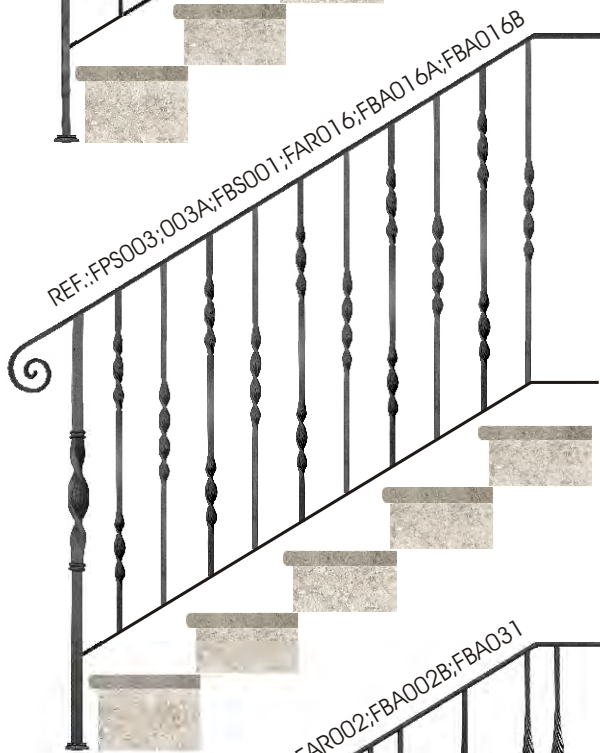
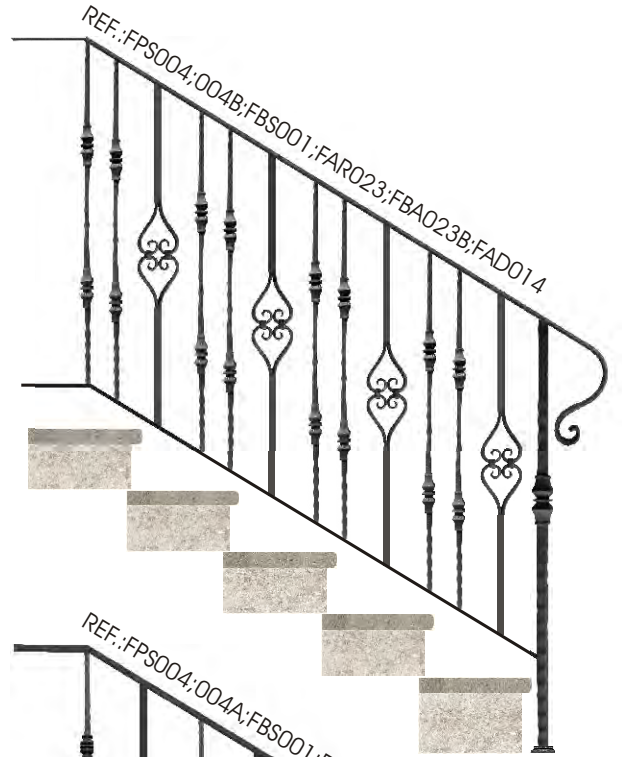
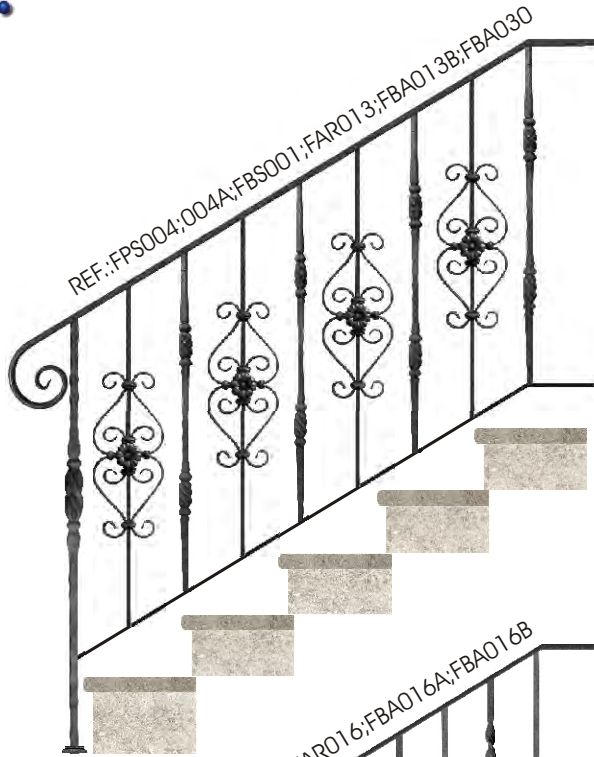

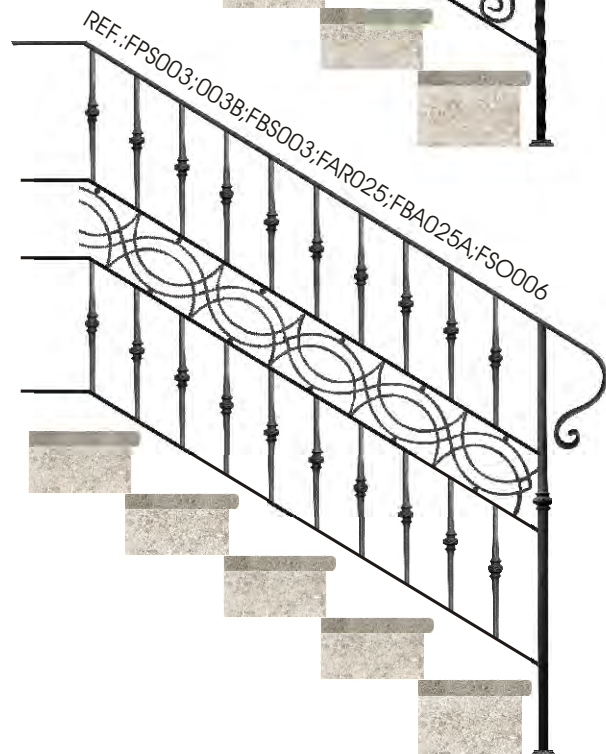
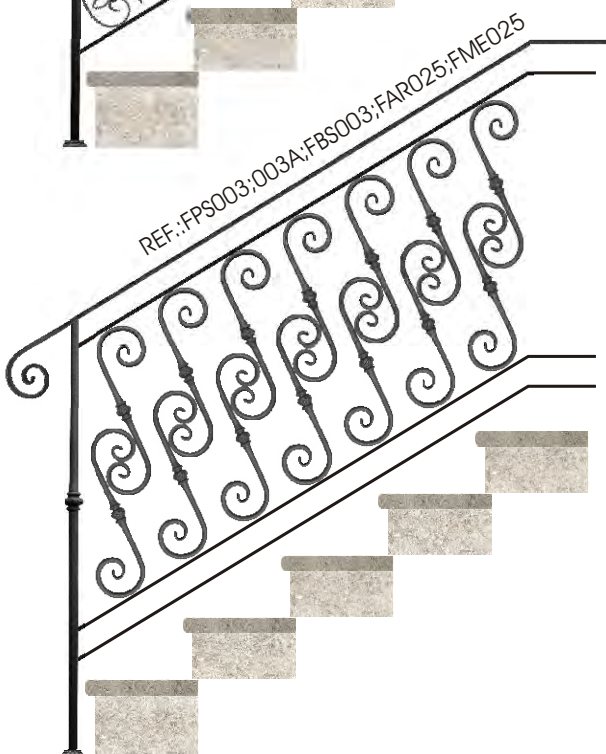
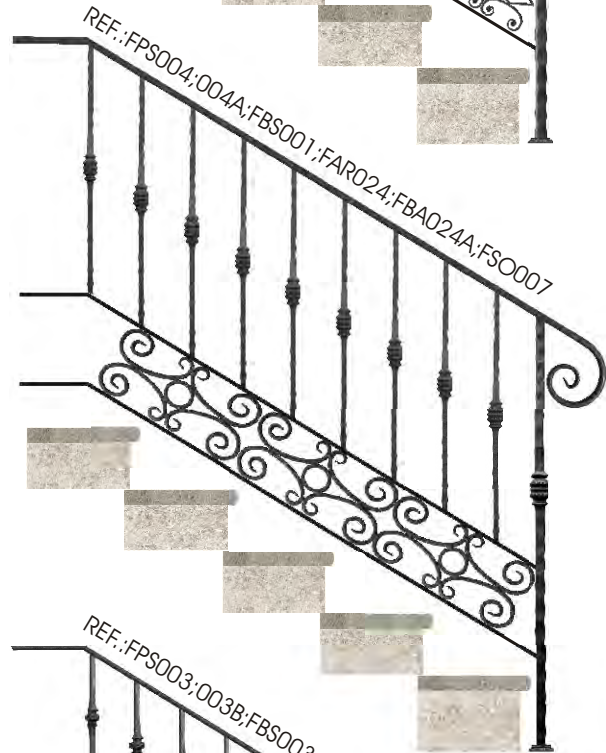
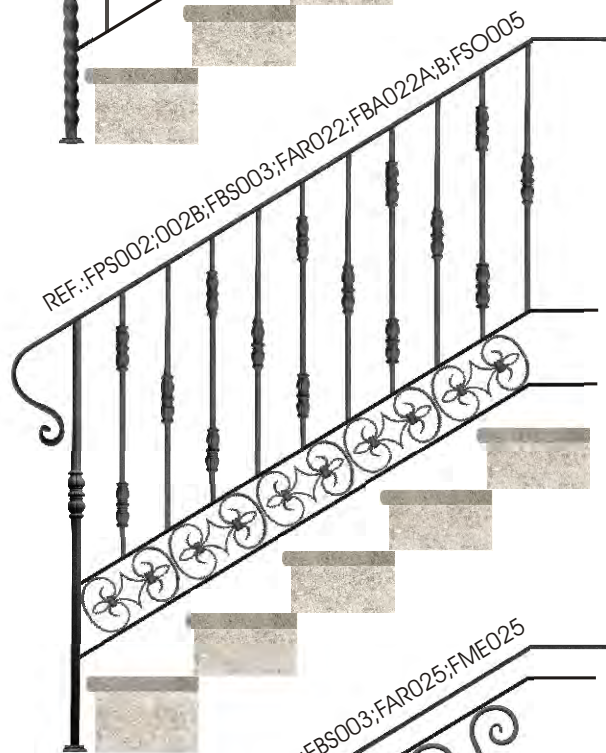
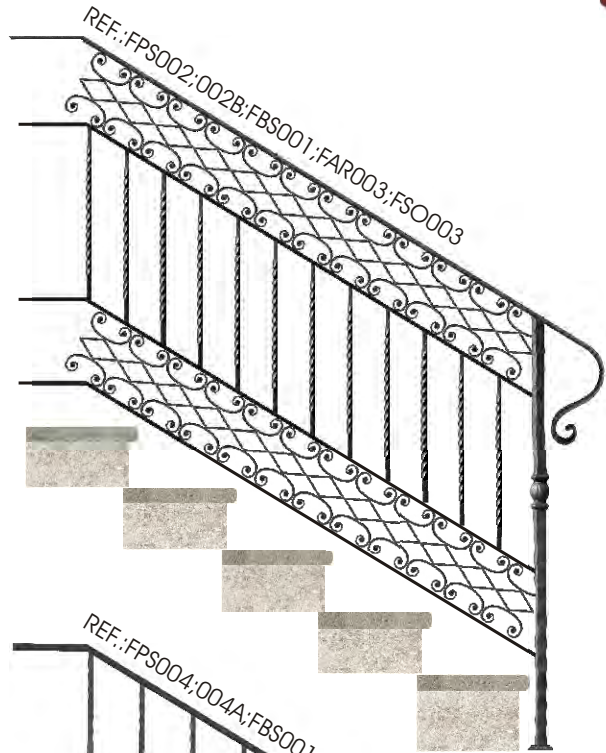
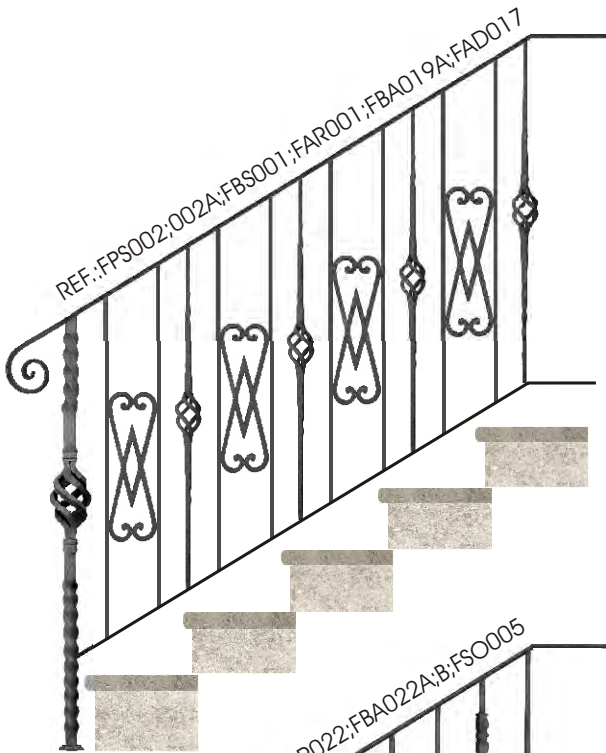



ESCALERAS / FORJA

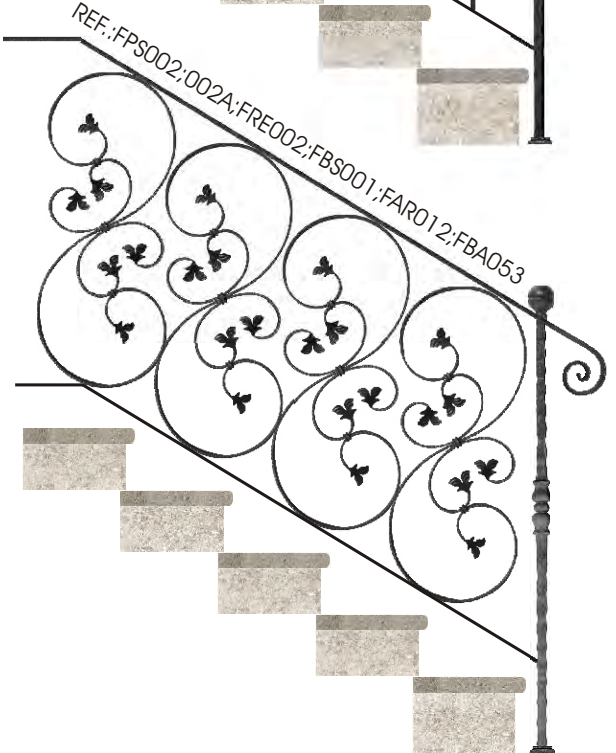
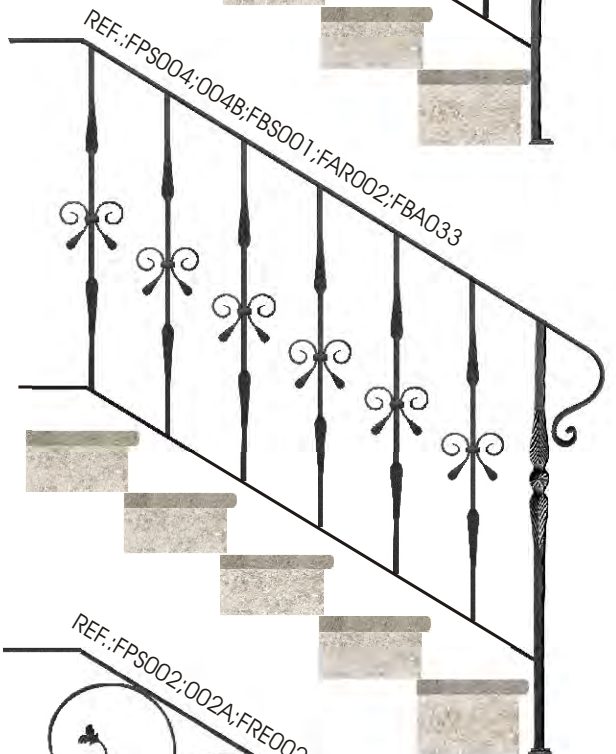
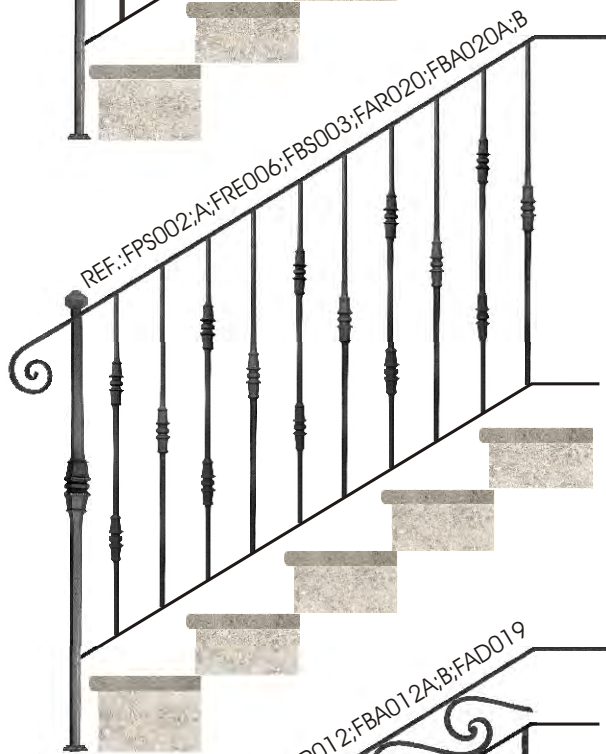
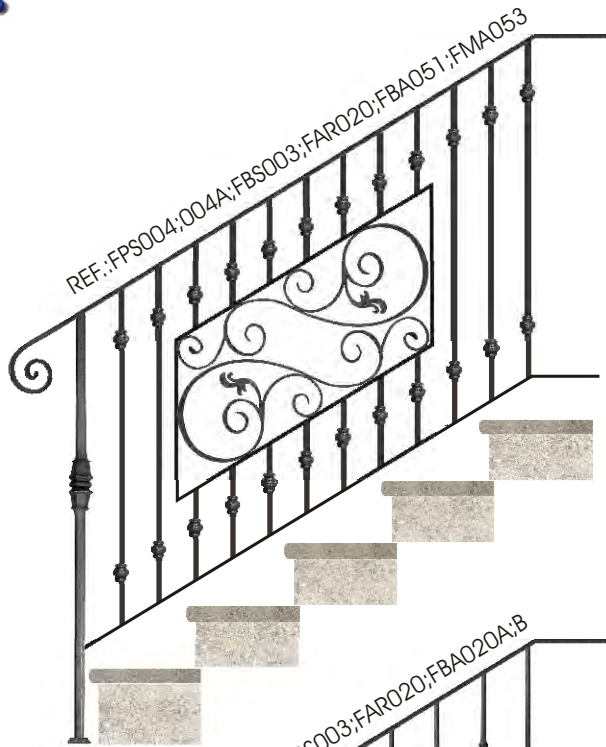

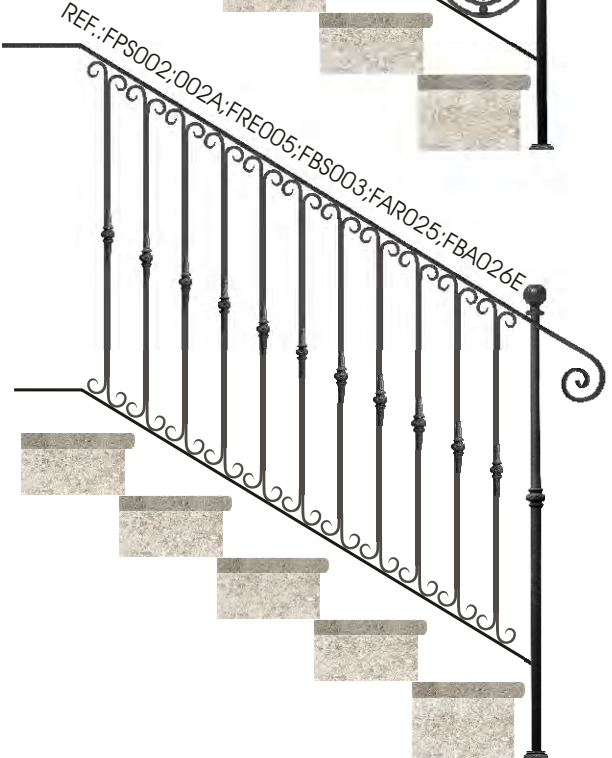
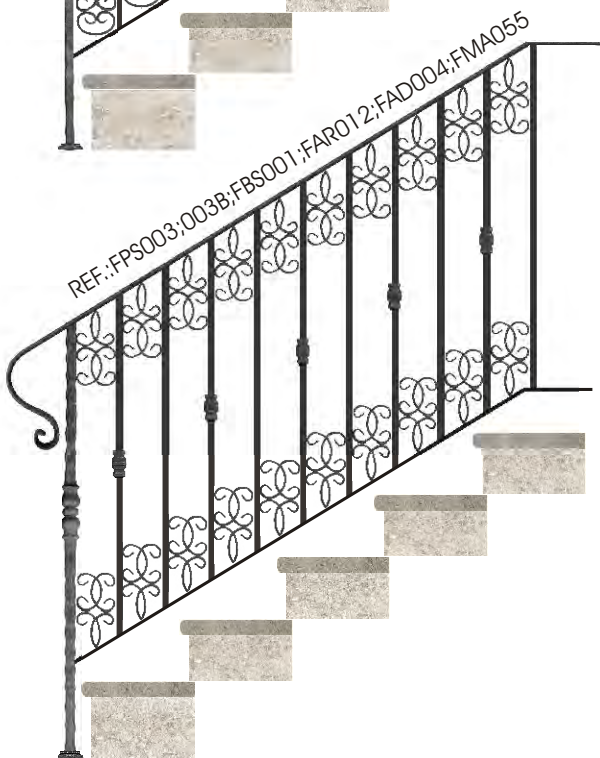
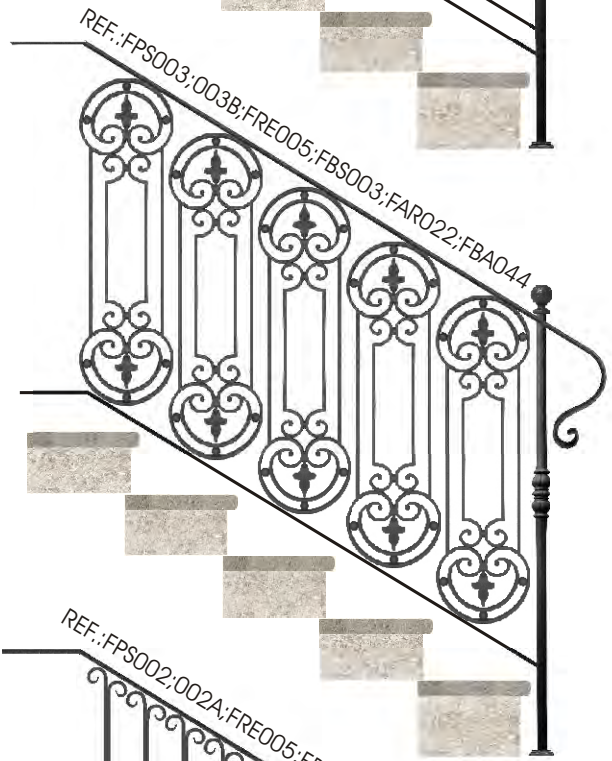
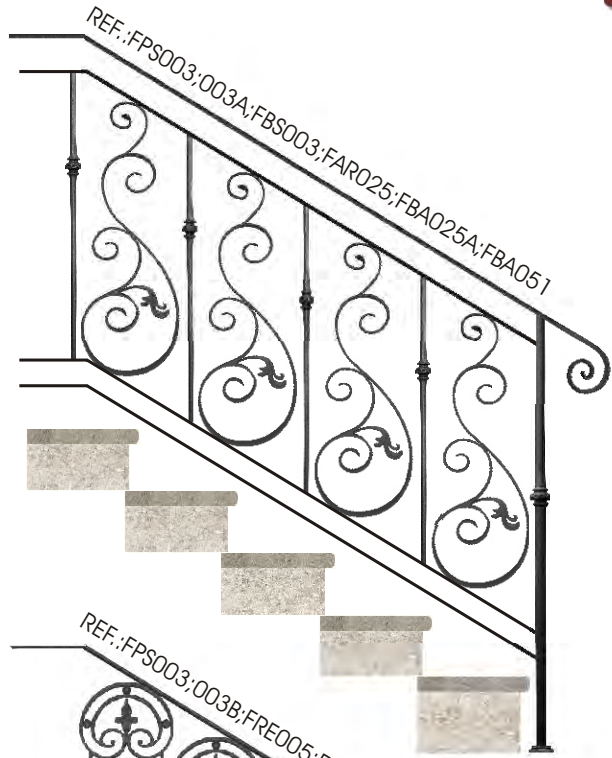
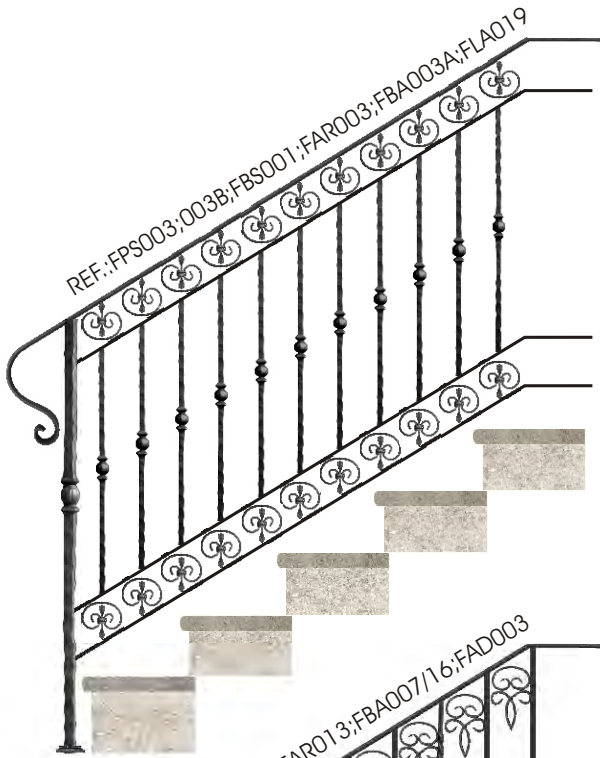

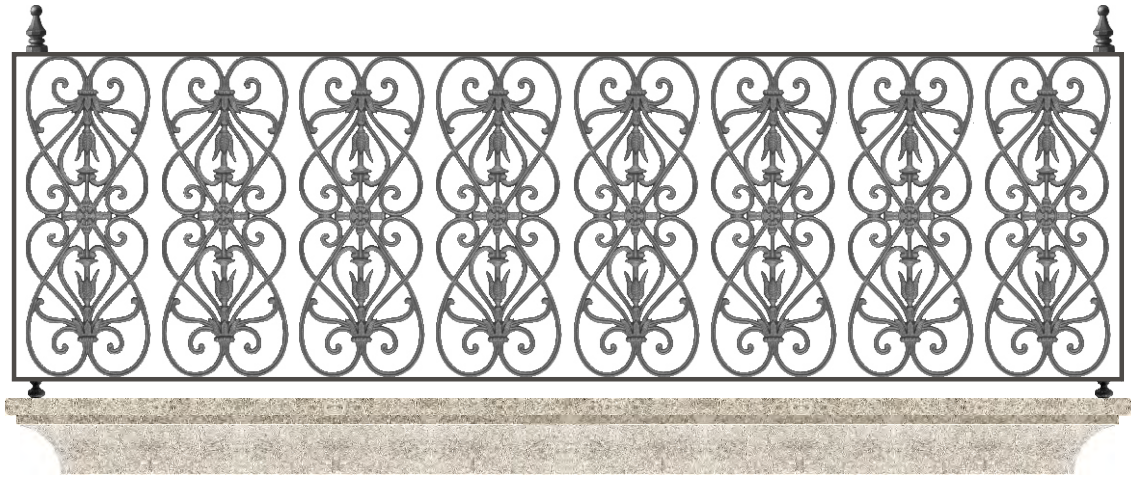

REF.:AC061;RE009;RE030

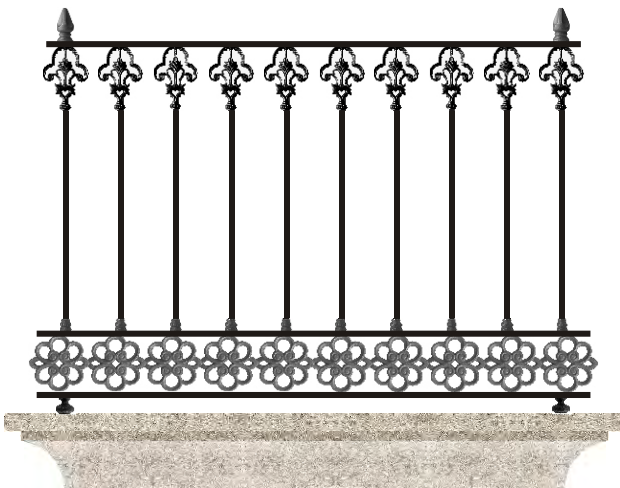

REF.:AD045;MA029;RE009;RE031;SO062

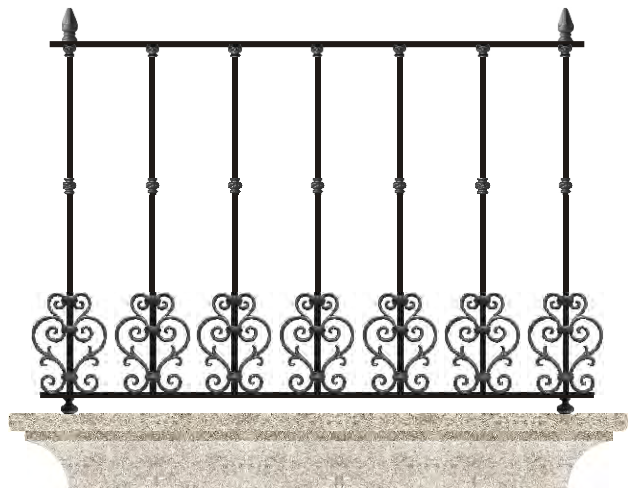

REF.:AD093;MA049;MA050;RE009;RE031



REF.:AC060;BA060;RE031



REF.:AD086;MA044;RE030;SO061

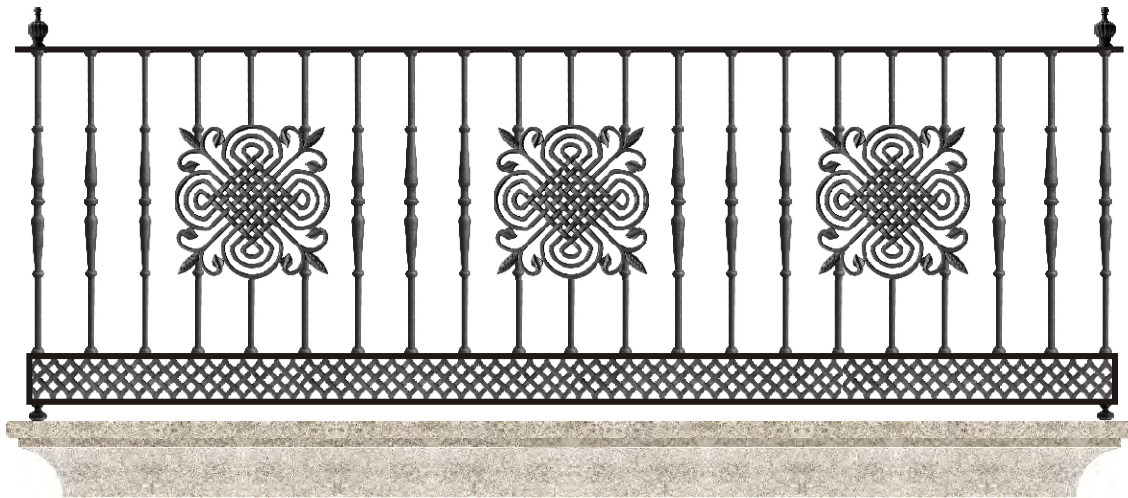

REF.:BA027870;SO059;AC028;RE021R;RE009



REF.:AD056;ADM056;MA046;MA047;RE014R;RE009



REF.:BA062870;BA053;RE014R;RE009

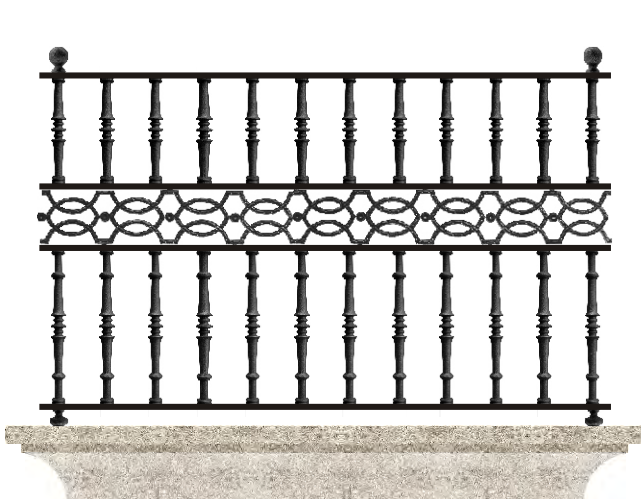

REF.:SO056;BA065370;500;RE027M;RE009H



REF.:AC056;RE022;RE009

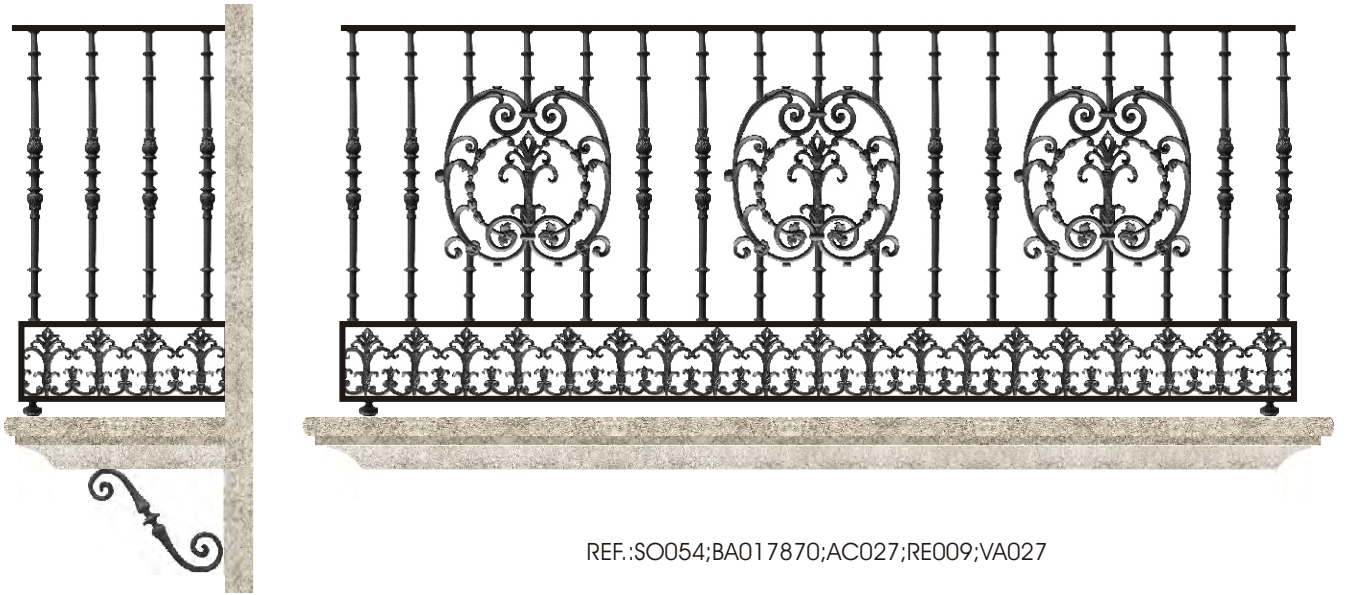

REF.:SO054;BA017870;AC027;RE009;VA027

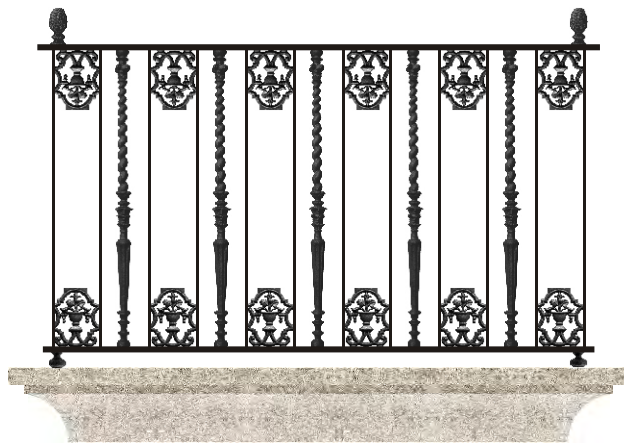

REF.:AD051;BA066;RE014R;RE009H



REF.:ADG067;ADP067;MA028;RE010R;RE009H



REF.:AD041;AD043;RE014R;RE009H

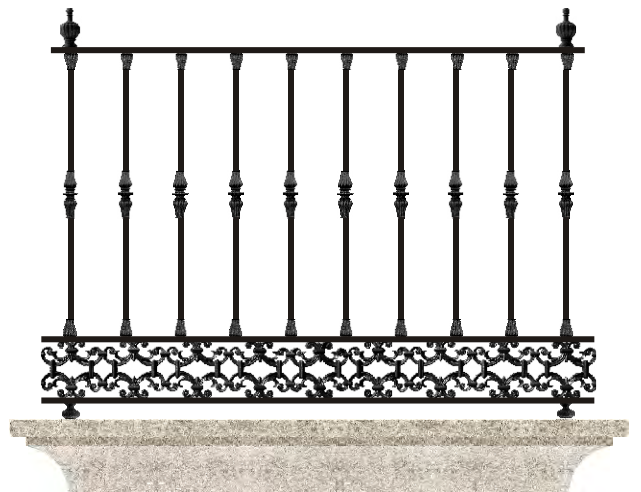

REF.:SO053;MA012;MA011;RE021R;RE009H

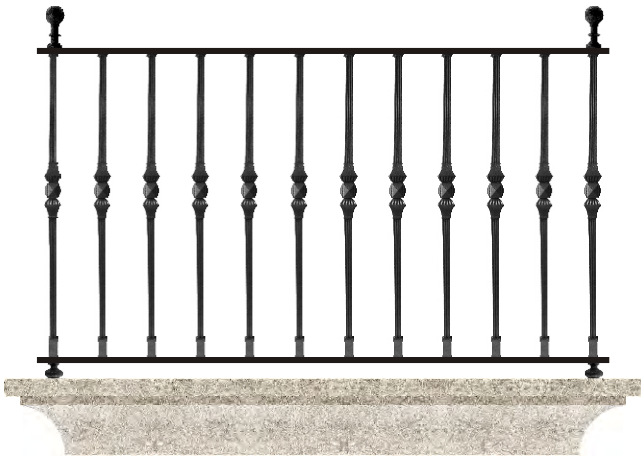

REF.:BA029870;RE010;RE009

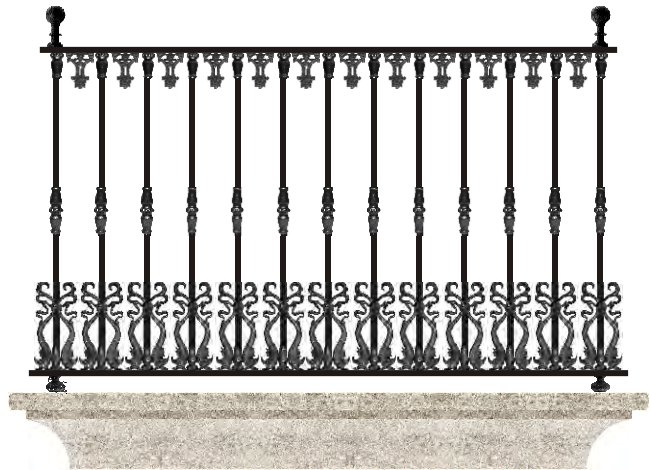

REF.:AD048;AD064;MA030;MA031;RE010R;RE009H



REF.:BA0611000;MA026;MA025;RE027M;RE009



REF.:AD090;MA043;MA042;RE014R;RE009



REF.:AC052;RE014R;RE009



REF.:SO055;BA065870;RE009H

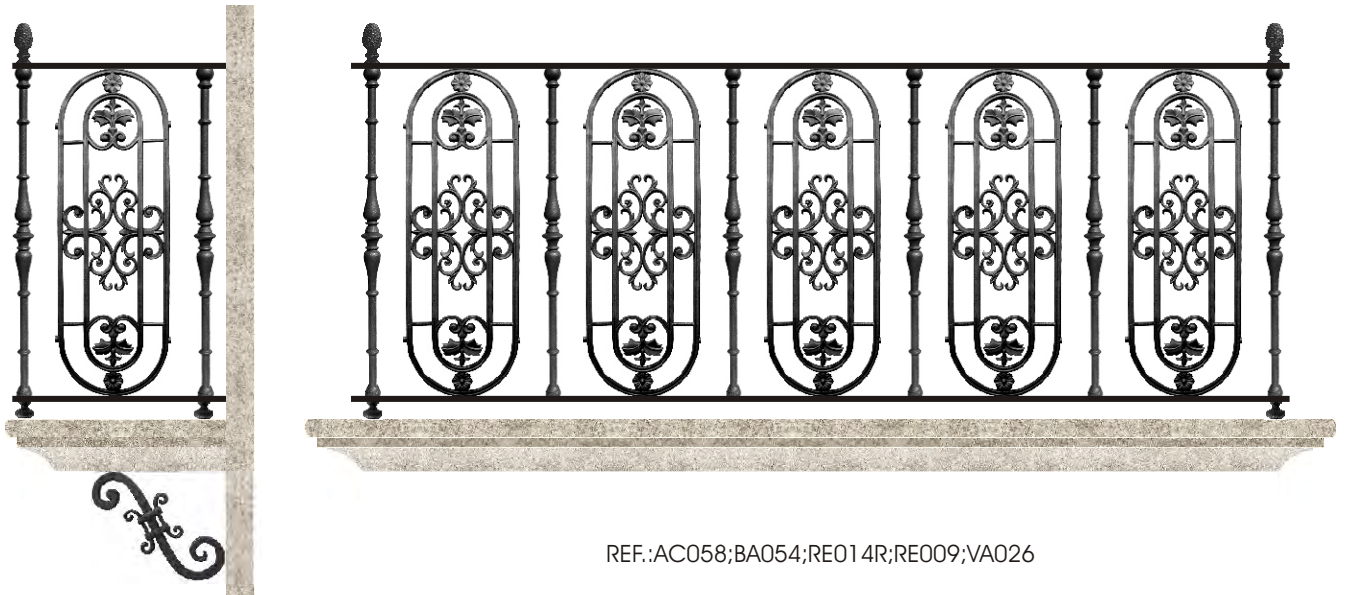

REF.:AC058;BA054;RE014R;RE009;VA026

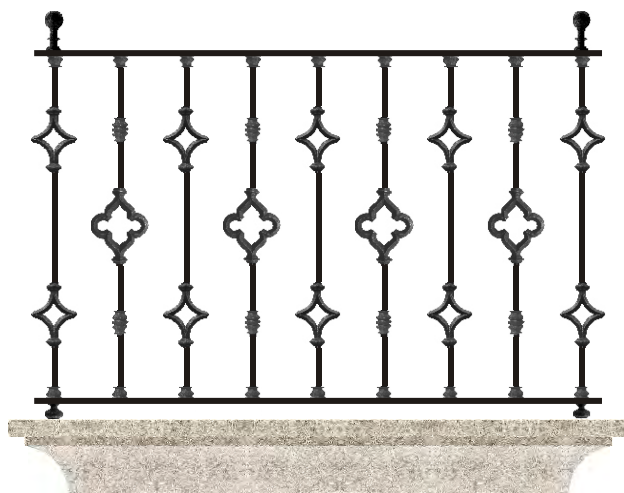

REF.:AD058;AD088;MA048;MA044;RE010R;RE009



REF.:AD040;AD083;MA048;MA044;RE010R;RE009



REF.:AD057;AD070;MAP010;RE014R;RE009

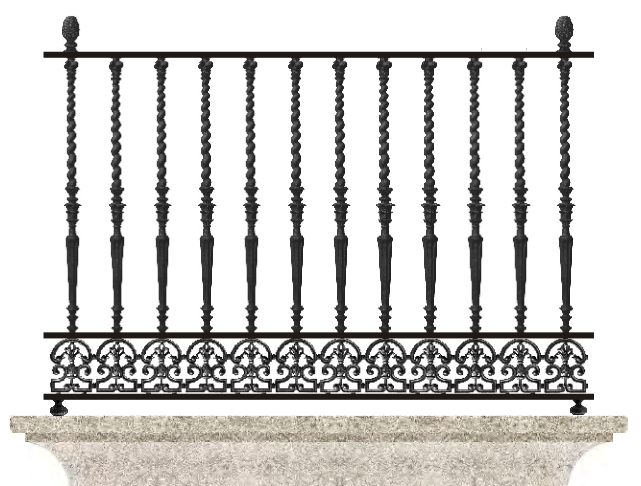

REF.:SO058;BA066;RE014R;RE009H

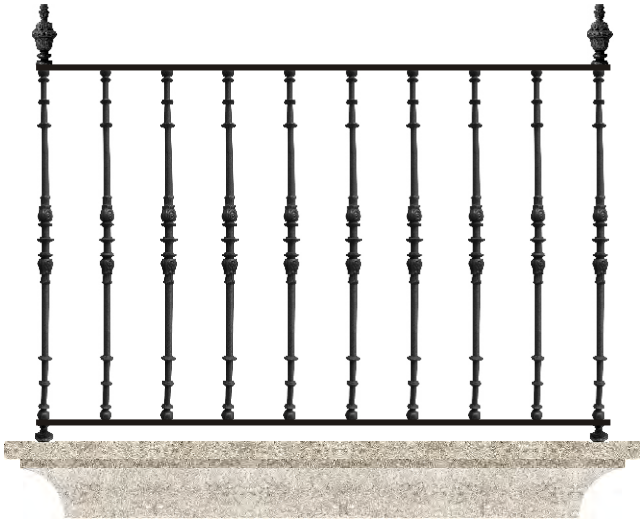

REF.:BA0171000;RE022;RE009

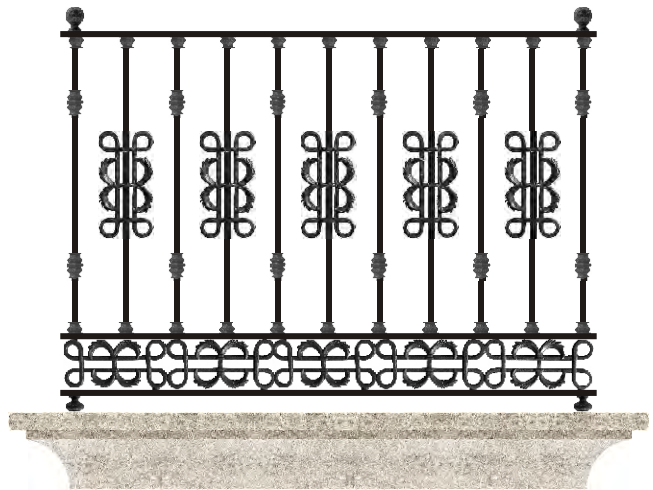

REF.:SO050;AD042;MA048;MA044;RE010R;RE009

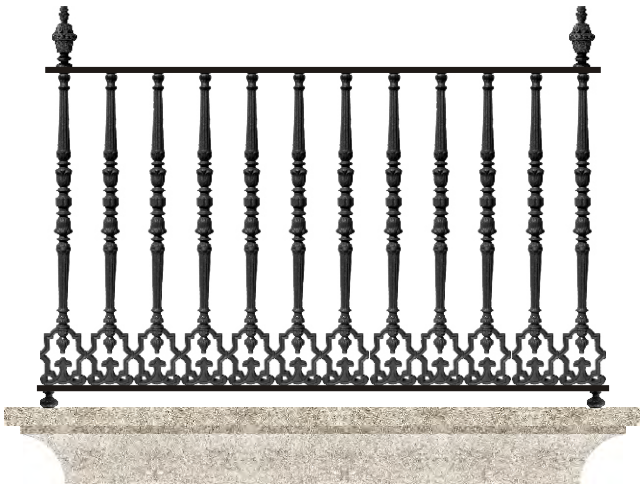

REF.:BA064;RE022;RE009



REF.:AC053;MA043;AD045;RE021R;RE009



REF.:AD072;MA128;MA129;RE014R;RE009



REF.:SO049;AC028;MA012;MA011;RE021R;RE009H

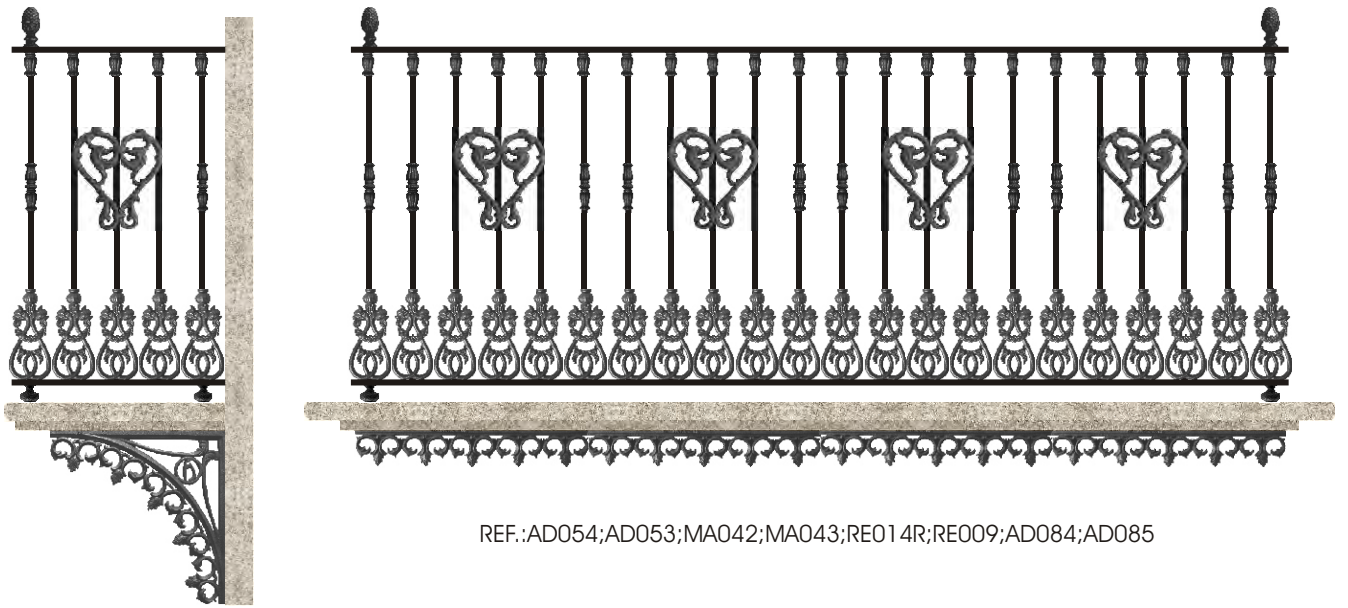

REF.:AD054;AD053;MA042;MA043;RE01 4R;RE009;AD084;AD085



REF.:ADC043;ADC041;MA048;MA044;RE01 4R;RE009H

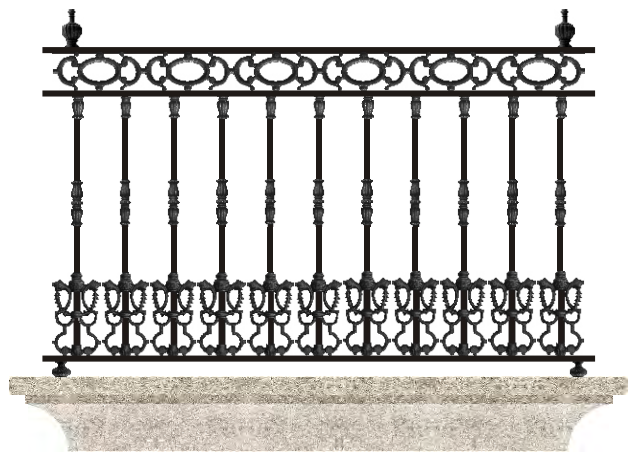

REF.:ADG055;AD052;MA043;MA042;RE021R;RE009H



REF.:AD042;AD062;MA012;RE022;RE009H

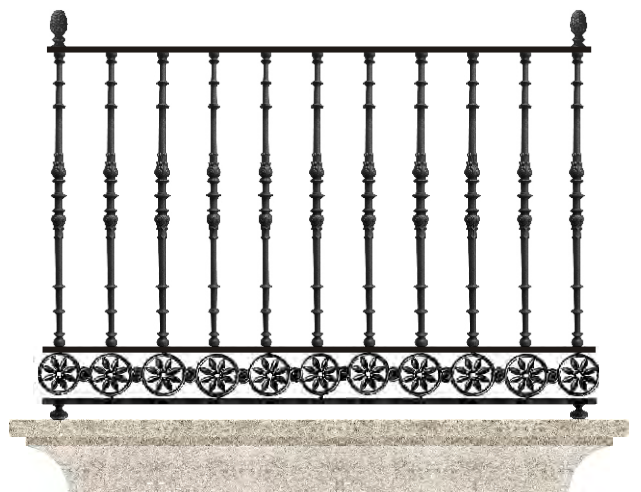

REF.:SO057;BA01 7870;RE01 4R;RE009H



REF.:AD134;MA131;MA132;RE014R;RE009

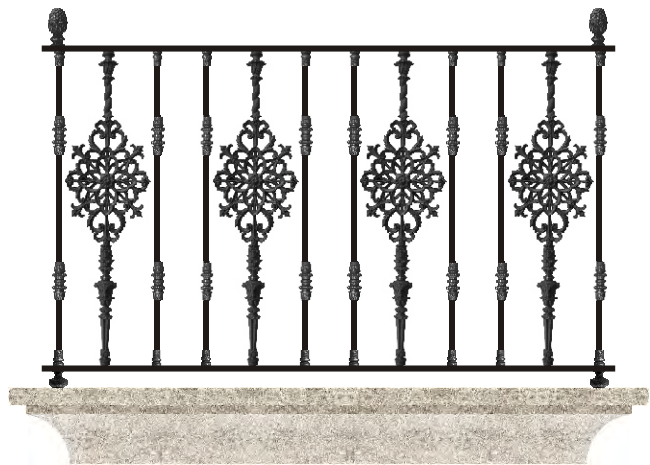

REF.:BA104900;MA131;MA132;RE014R;RE009



REF.:AD111;AD114;MA132;MA131;RE014R;RE009

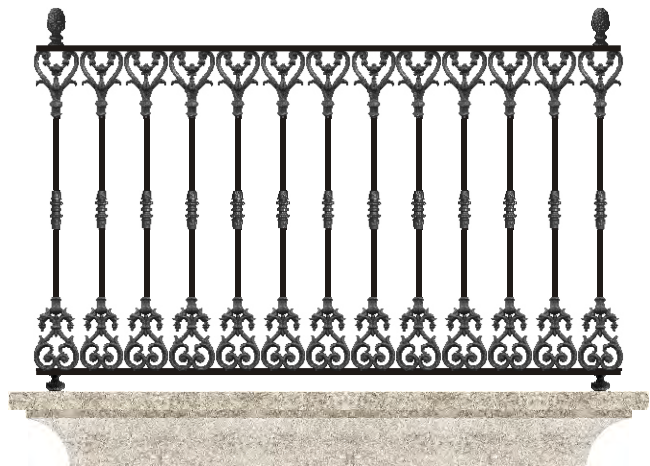

REF.:AC113;AC114;MA131;RE014R;RE009



REF.:AD169;SO114;MA129;MA128;RE010R;RE009

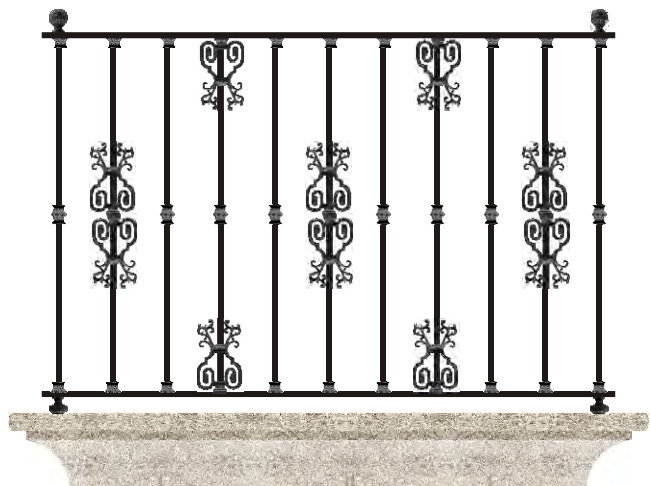

REF.:AD136;MA128;MA129;RE010R;RE009



REF.:AC054;FBA002B;VA074;VA086;RE009;RE014R

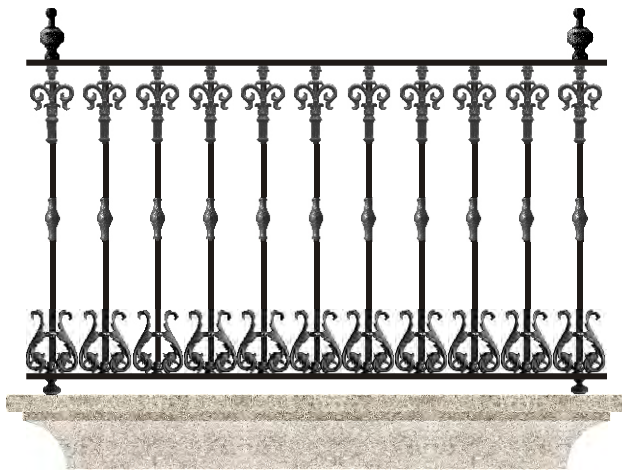

REF.:AD049;AD050;MA040;RE026;RE009

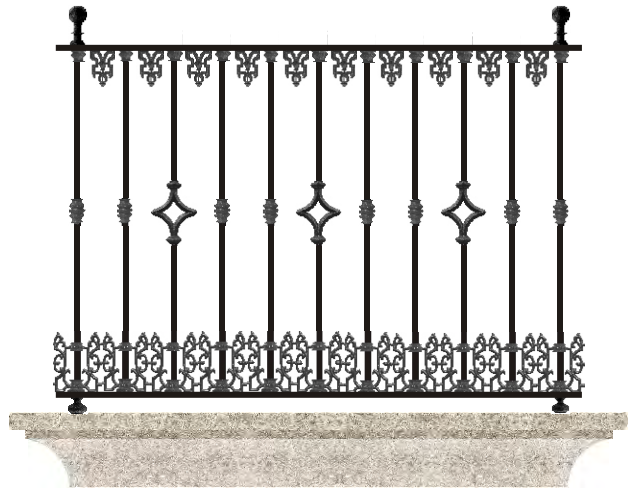

REF.:ADC087;AD088;AD063;MA048;MA044;RE010R;RE009

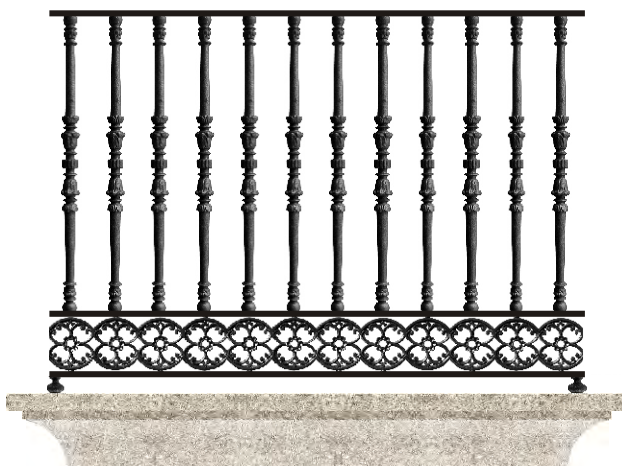

REF.:SO052;BA060;RE009H

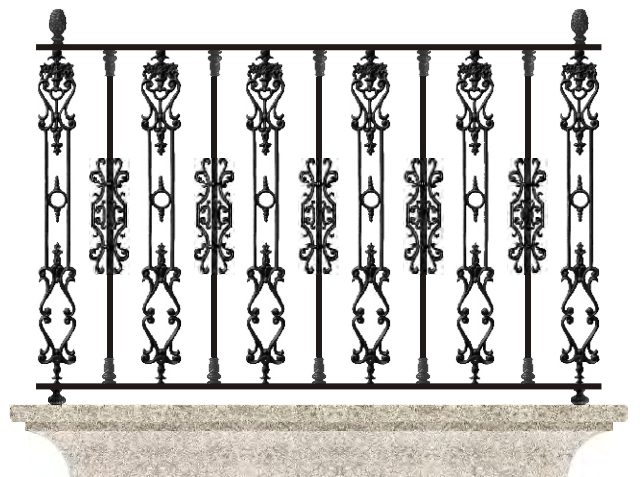

REF.:AC050;AD070;MAP010;RE014R;RE009

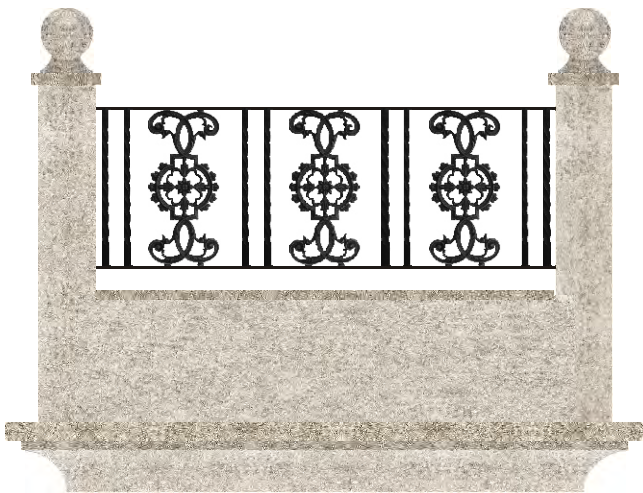

REF.:AD081

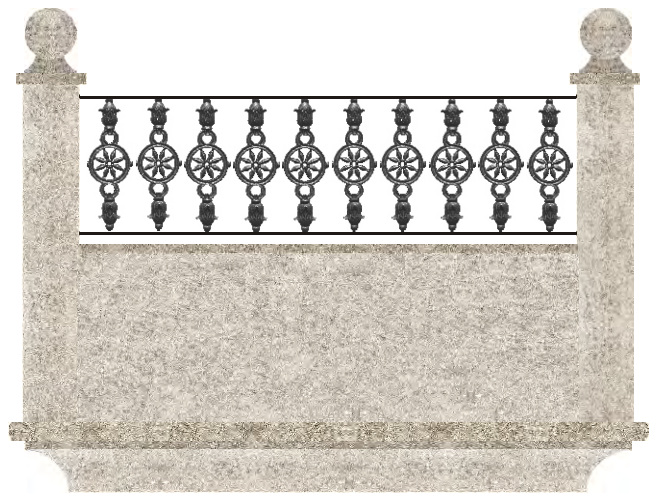

REF.:AD046

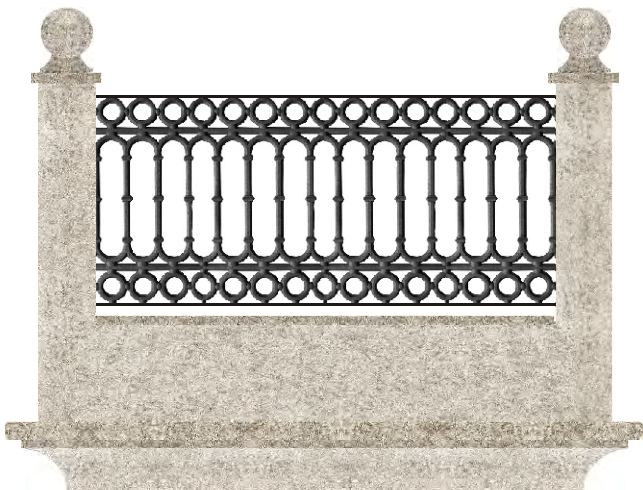

REF.:AC057



REF.:BA021



REF.:AC041;AC042;MA043



REF.:CR025;CR026



REF.:FPS008;FRE005;FAR025;FBA086;FME012



REF.:FPS003;FAD047;FBA025A;FBA025B;RE009

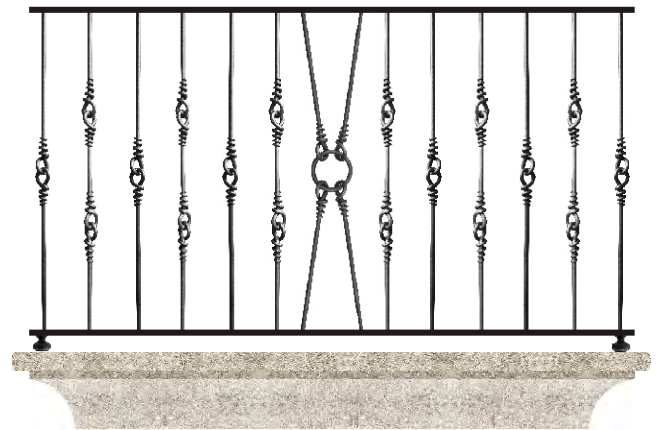

REF.:FPS009;FBA058A;FBA058B;FBA059;RE009



REF.:FPS009;FAR021;FRE005;FBA088



REF.:FPS004;FAR021;FRE013;FBA021A;FBA070



REF.:FPS009;FBA023A;FBA087;FME023;FRE006;RE009



REF.:FPS003;FBA066A;FBA066B;RE009



REF.:FPS002;FAD045;FMA055;RE009H

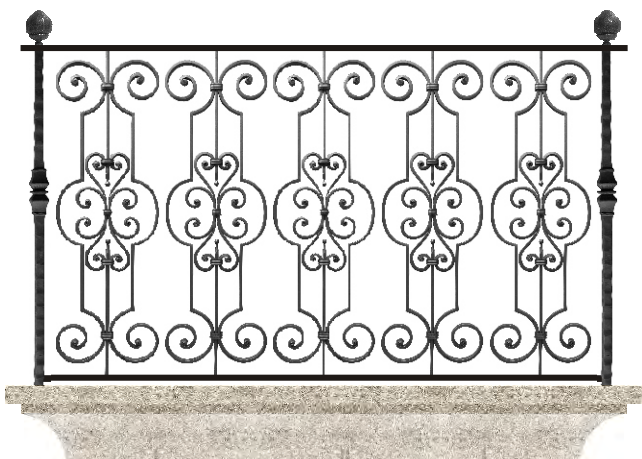

REF.:FPS003;FRE004;FAR023;FBA078



REF.:FPS008;FBA024A;FBA085;RE009;VA094

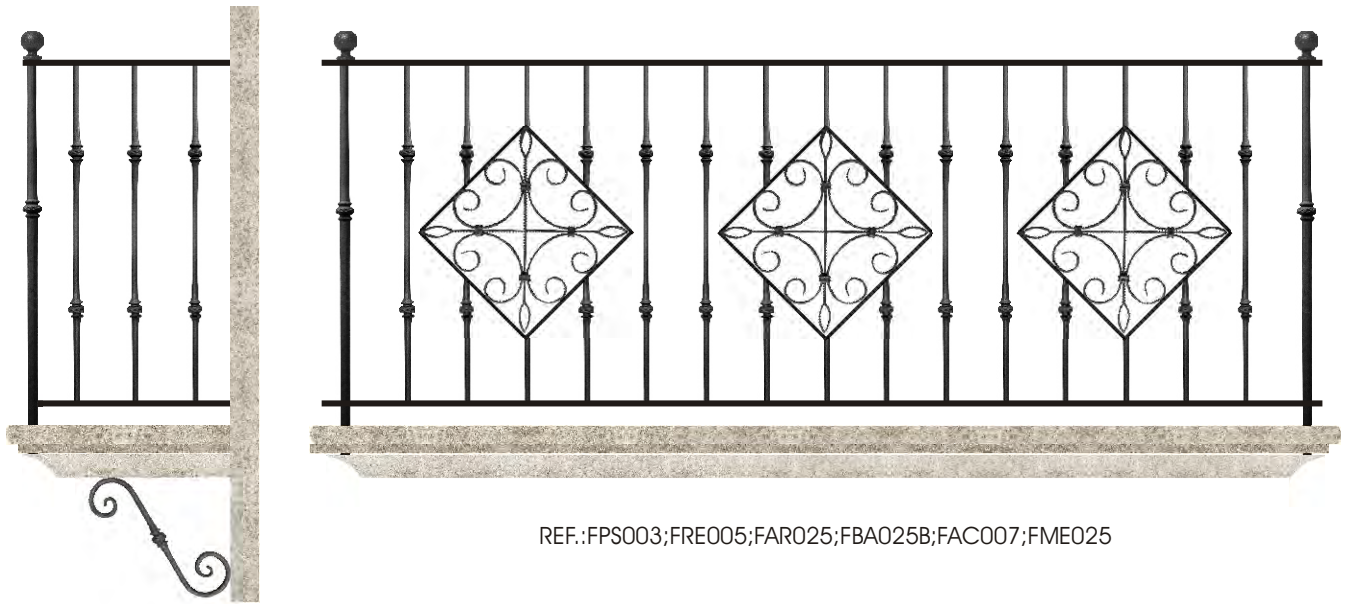

REF.:FPS003;FRE005;FAR025;FBA025B;FAC007;FME025

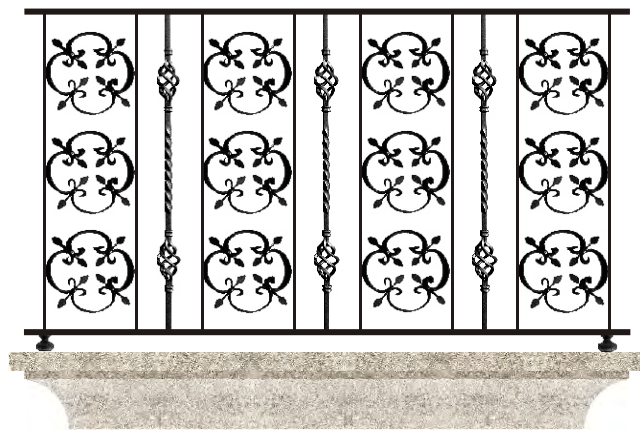

REF.:FPS002;FBA001B;FVA010;RE009H



REF.:FPS003;FRE006;FBA003B;FBA006;RE009



REF.:FPS002;FBA022A;FBA022B;FL002;RE009H



REF.:FPS004;FRE005;FAD008;FC003;FMA055;RE009



REF.:FPS004;FBA037;FBA038;FME001;RE009



REF.:FPS003;FBA016A;FBA016B;FSO007;RE009

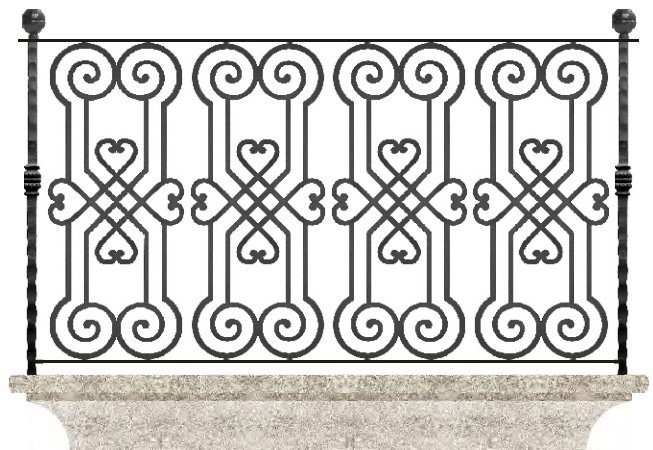

REF.:FPS002;FRE002;FAR024;FBA040



REF.:FPS003;FRE006;FBA016A;FBA039;RE009

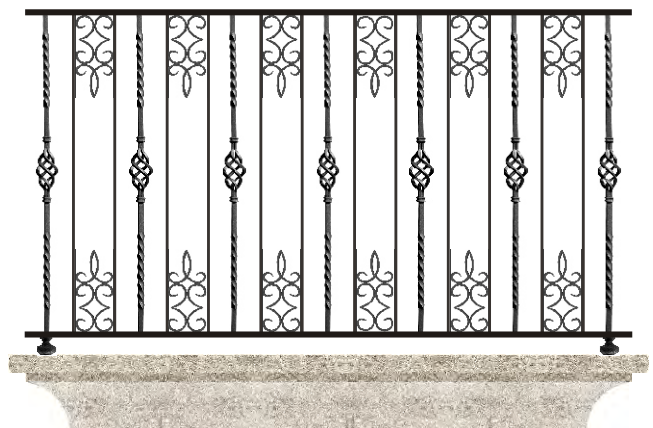

REF.:FPS004;FBA001A;FAD006;RE009H

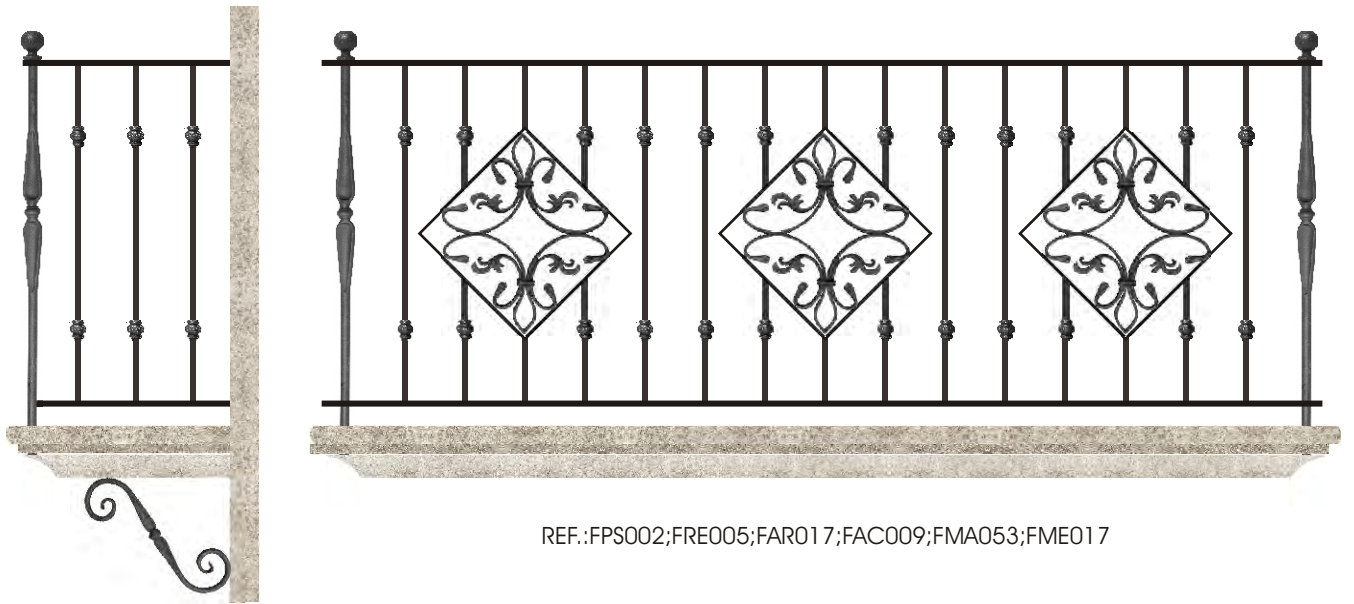

REF.:FPS002;FRE005;FAR017;FAC009;FMA053;FME017



REF.:FPS004;FAD011;FMA054;RE009



REF.:FPS004;FBA016B;FBA007;RE009



REF.:FPS004;FBA027;FE002;;RE009H

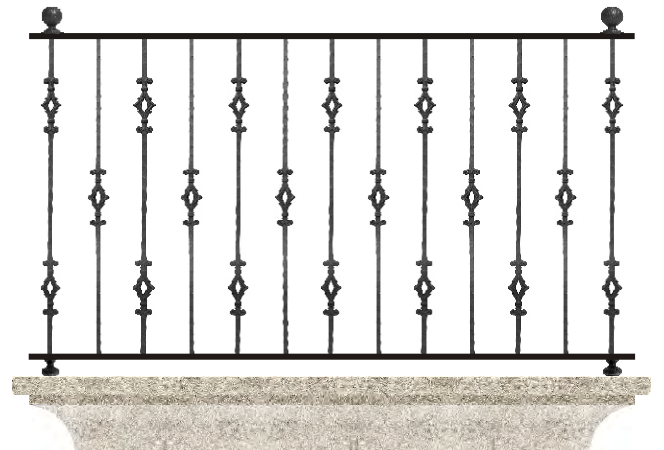

REF.:FPS003;FRE005;FBA015A;FBA015B;RE009



REF.:FPS002;FBA024A;FAC006;FSO007;FME003;RE009



REF.:FPS003;FBA026;FBA042;RE009H



REF.:FPS003;FRE004;FAR023;FBA043



REF.:FPS002;FRE004;FBA023A;FLA019;RE009

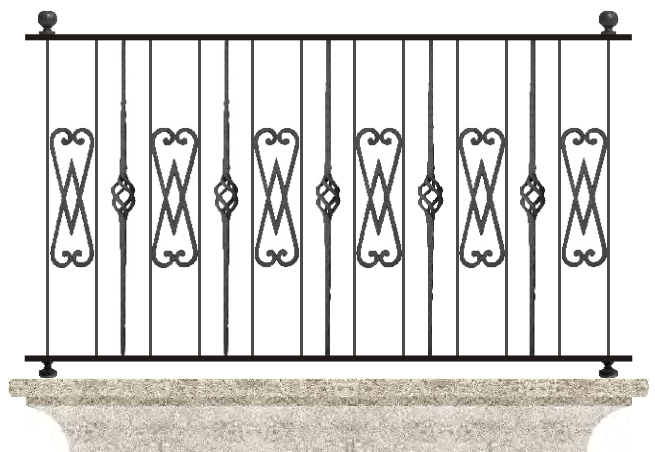

REF.:FPS003;FRE005;FBA019A;FAD017;RE009



REF.:FPS003;FBA025A;FBA041;FME025;RE009

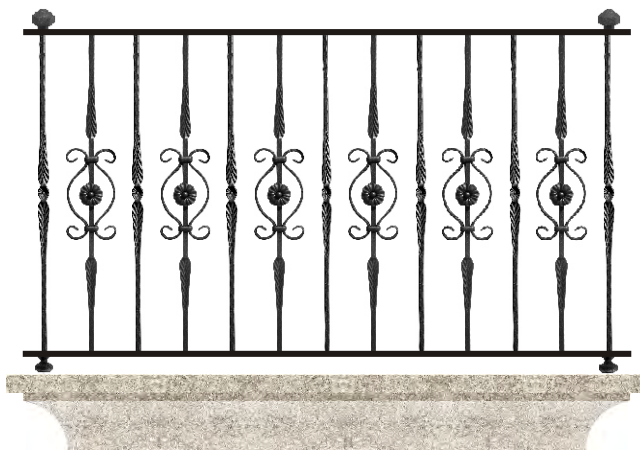

REF.:FPS002;FRE006;FBA002A;FBA032;RE009



REF.:FPS004;FAD002;FAD010;RE009



REF.:FPS003;FBA003A;FSO002;RE009H



REF.:FPS004;FBA011A;FBA011B;FAD019;RE009

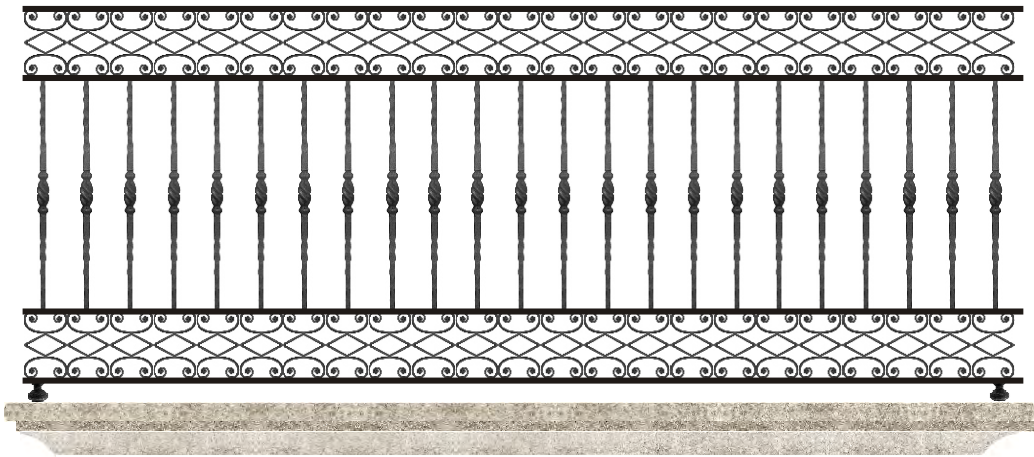

REF.:FPS004;FBA013A;FSO003;FME023;RE009

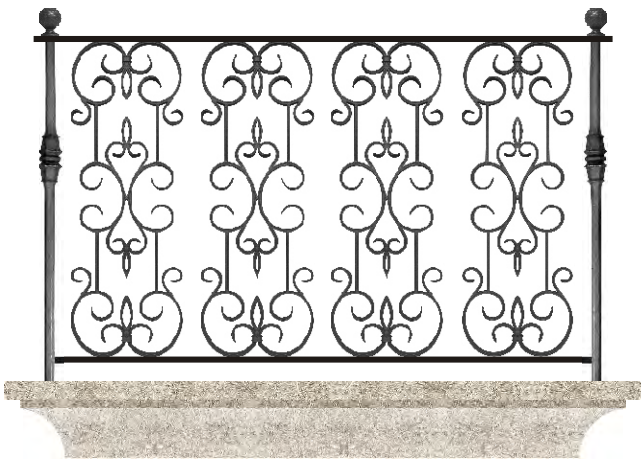

REF.:FPS002;FRE005;FAR020;FBA042

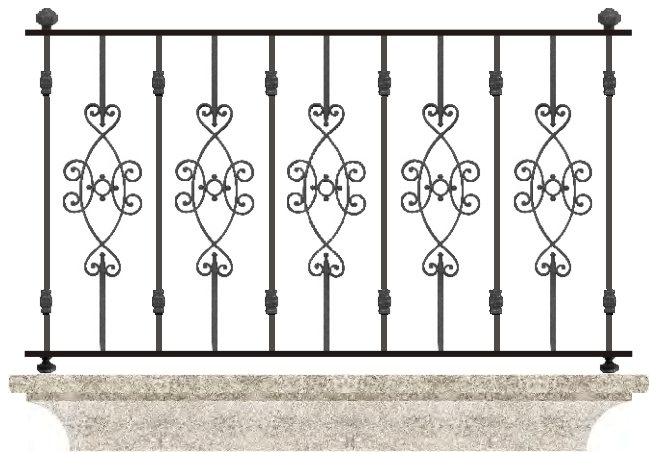

REF.:FPS002;FRE006;FBA036;FMA055;RE009

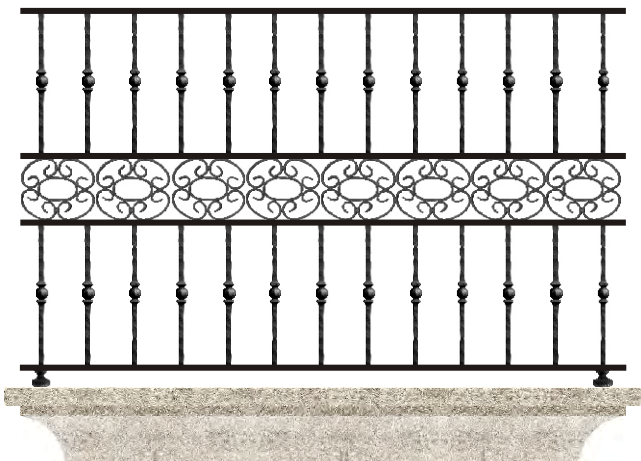

REF.:FPS002;FBA003A;FSO004;RE009H

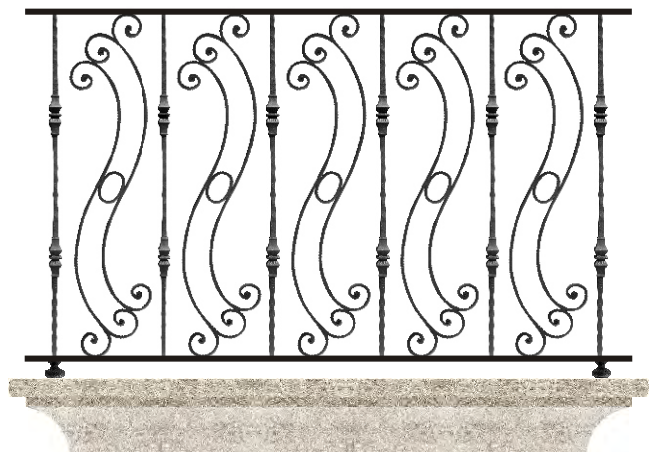

REF.:FPS004;FBA023B;FBA045E;RE009



REF.:FPS002;FRE006;FBA023A;FAD022;FME023;RE009

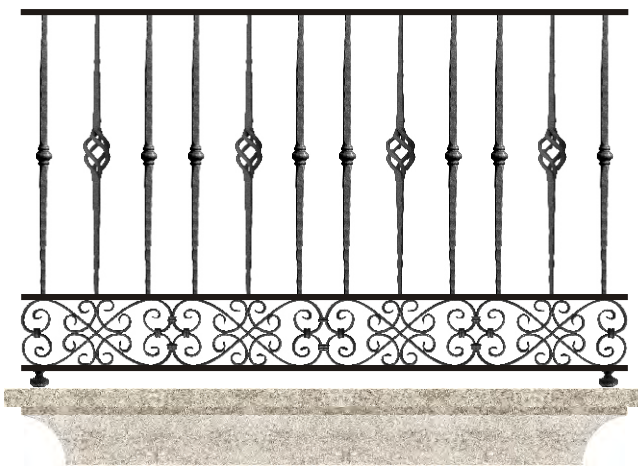

REF.:FPS002;FBA004A;FBA019A;FSC001;RE009H

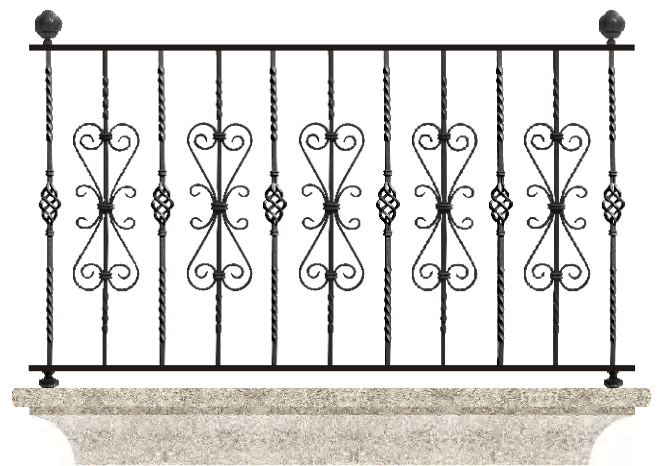

REF.:FPS002;FRE004;FBA001A;FBA005;RE009H



REF.:FPS004;FE002;FMA055;FLA020;RE009H

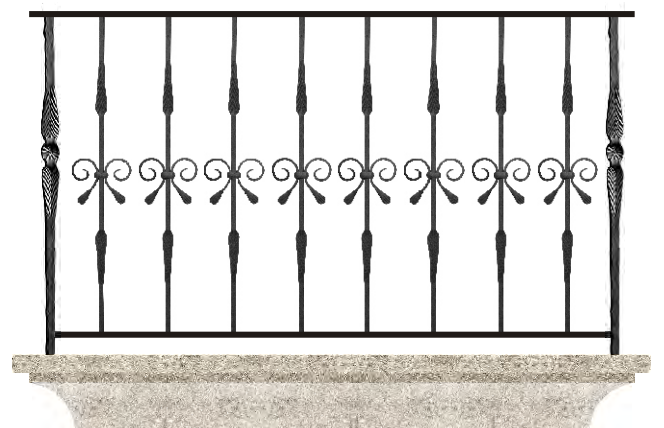

REF.:FPS004;FAR002;FBA033

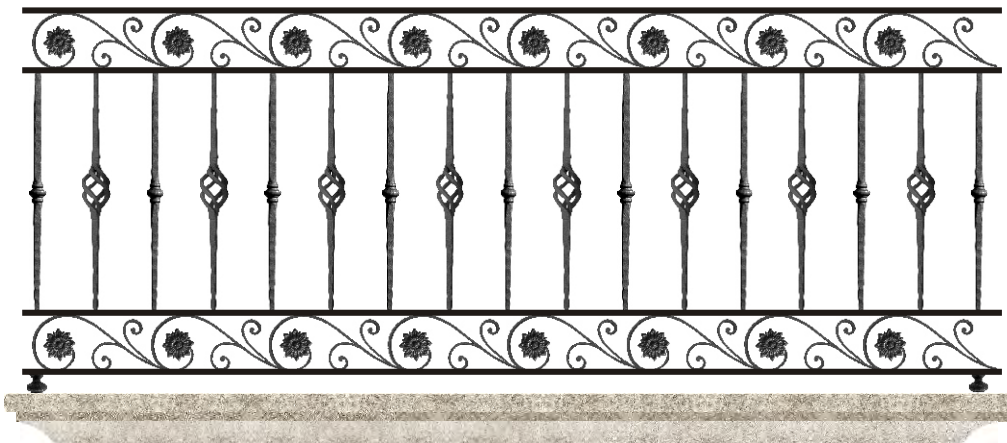

REF.:FPS004;FBA004A;FBA019A;FAD018;FME001;RE009



REF.:FPS004;FBA007;FAD003;RE009H



REF.:FPS003;FRE005;FAR018;FBA044



REF.:FPS002;FRE005;FBA020A;FBA051;RE009H



REF.:FPS004;FBA011A;FSO005;RE009H

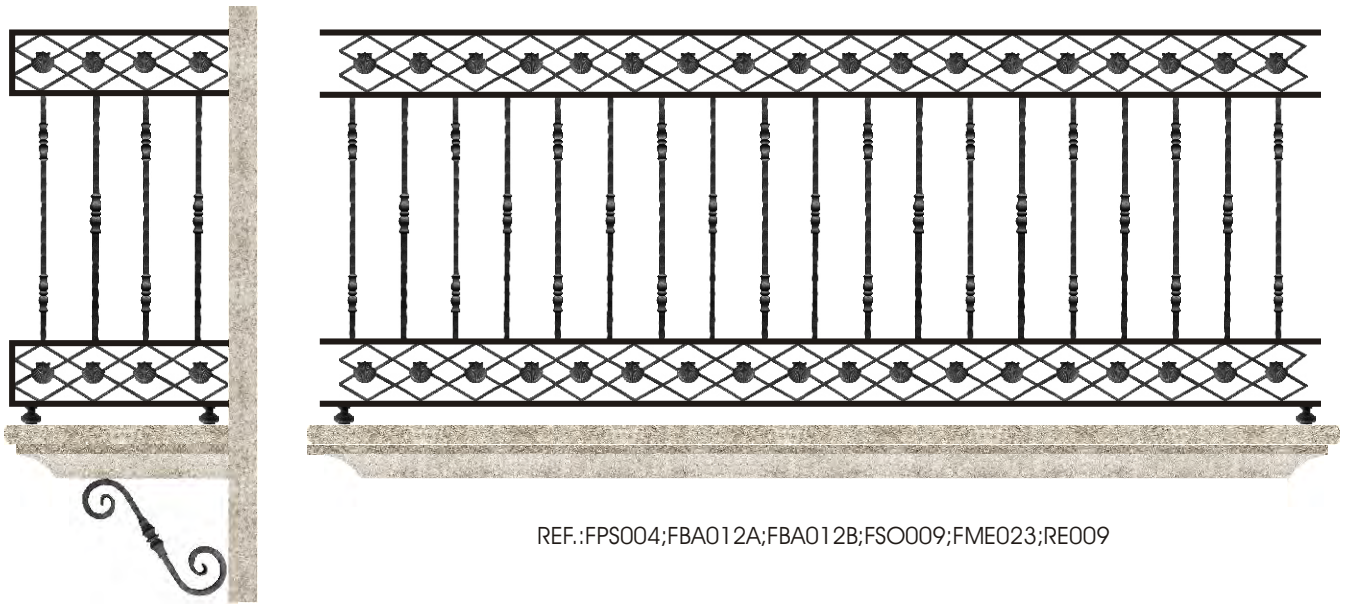

REF.:FPS004;FBA012A;FBA012B;FSO009;FME023;RE009



REF.:FPS004;FAD007;FMA054;FVA003;RE009



REF.:FPS003;FRE005;FAD004;FAD022;RE009

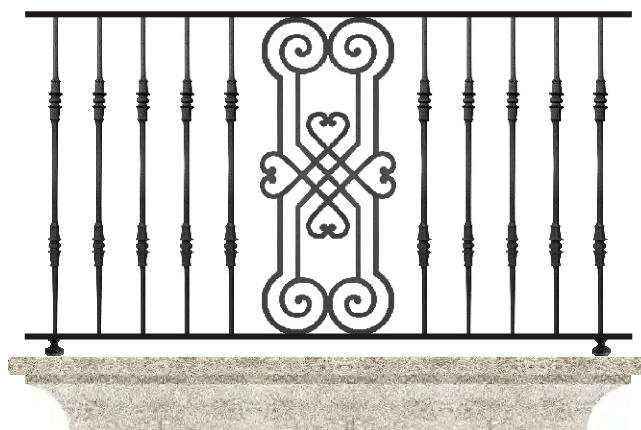

REF.:FPS003;FBA020B;FBA040;RE009H

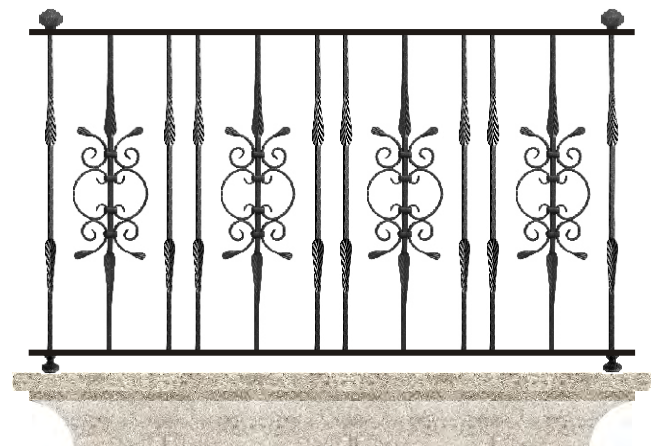

REF.:FPS003;FRE006;FBA002B;FBA031;RE009



REF.:FPS004;FBA025B;FBA043;FME025;RE009



REF.:FPS002;FRE005;FAR021;FBA051;FVA026



REF.:FPS003;FBA017A;FSO008;RE009H

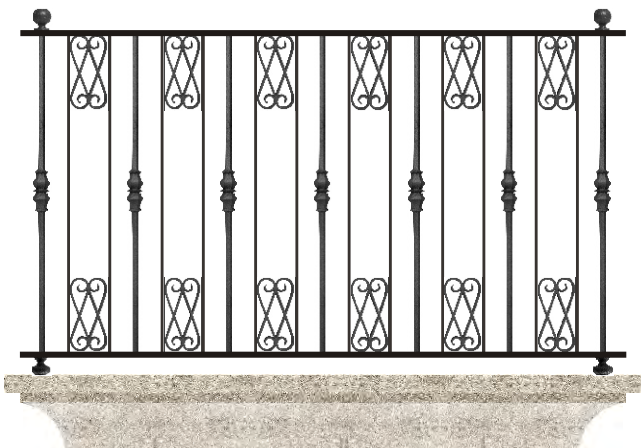

REF.:FPS002;FRE005;FBA021A;FAD015;RE009

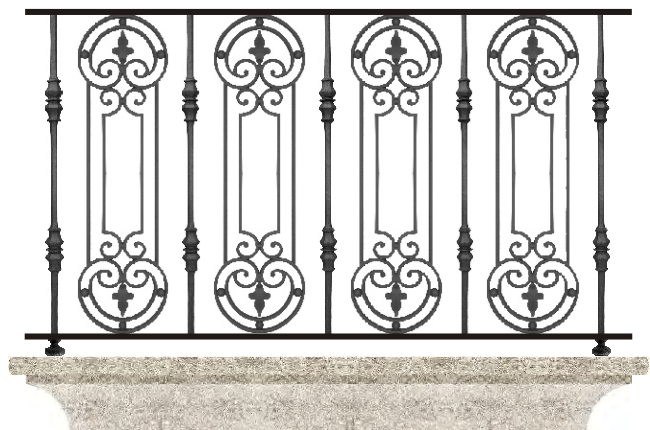

REF.:FPS004;FBA021B;FBA044;RE009H



REF.:FPS002;FBA021A;FAC008;FSO005;FME025;RE009

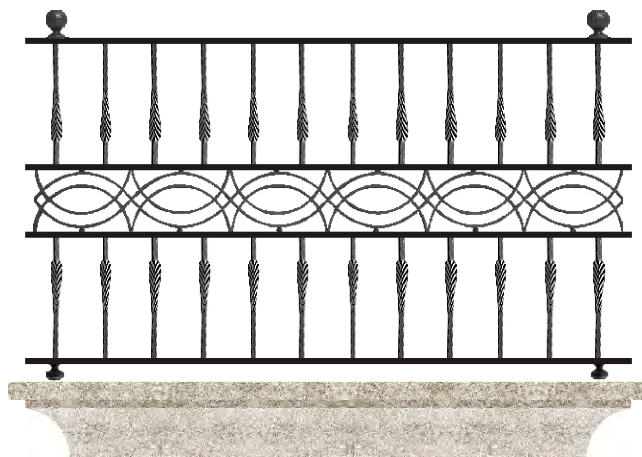

REF.:FPS002;FRE005;FBA002B;FSO006;RE009

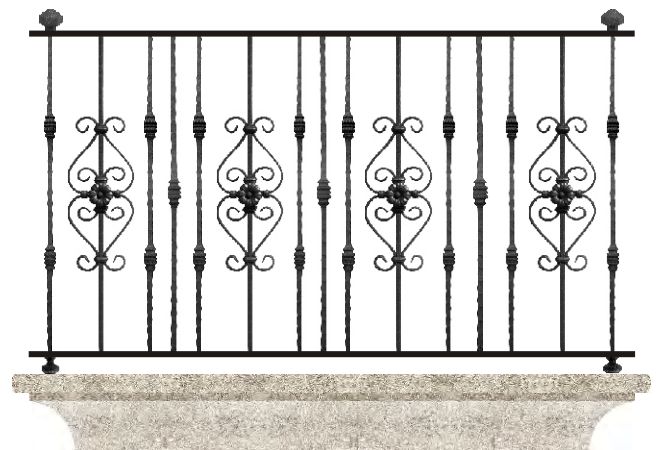

REF.:FPS003;FRE006;FBA024A;FBA024B;FBA030;RE009



REF.:FPS002;FRE004;FAR004;FBA034

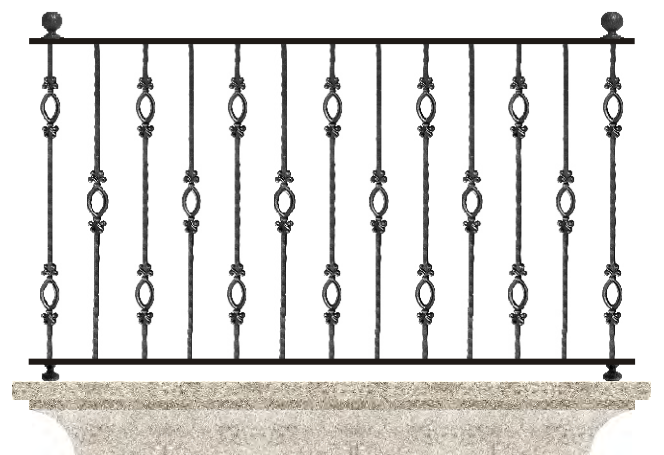

REF.:FPS003;FRE005;FBA014A;FBA014B;RE009



REF.:FPS002;FRE004;FAR004;FBA004A;FAD025;FME004

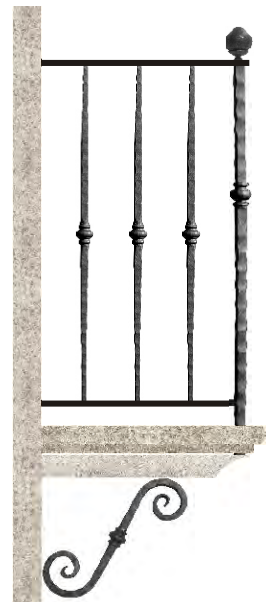

REF.:FPS003;FRE006;FBA012B;FBA035;RE009



REF.:FPS002;FRE002;FAR016;FBA041

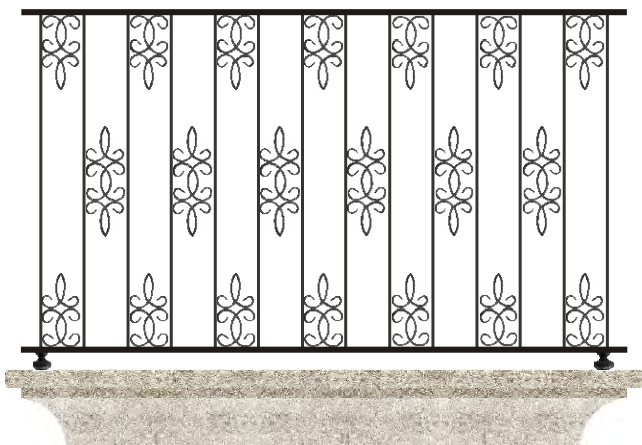

REF.:FPS004;FAD004;FAD005;RE009



REF.:FPS002;FBA018A;FSO010;RE009



REF.:FPS002;FRE001;FAC007;FC004



REF.:FPS003;FAC003;FAC004

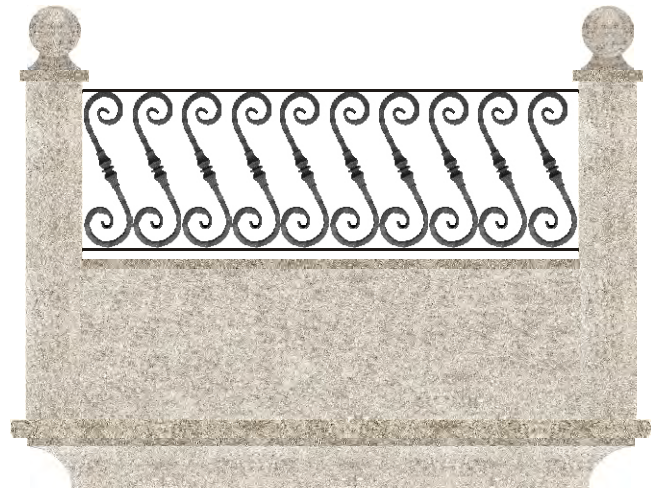

REF.:FPS002;FME023

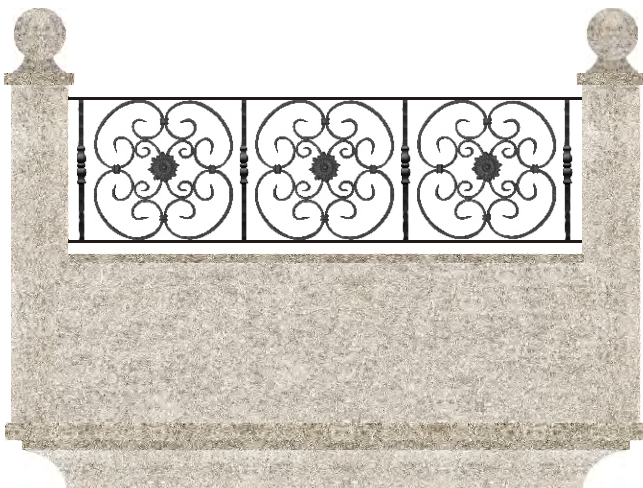

REF.:FPS003;FBA01 2A;FAD024

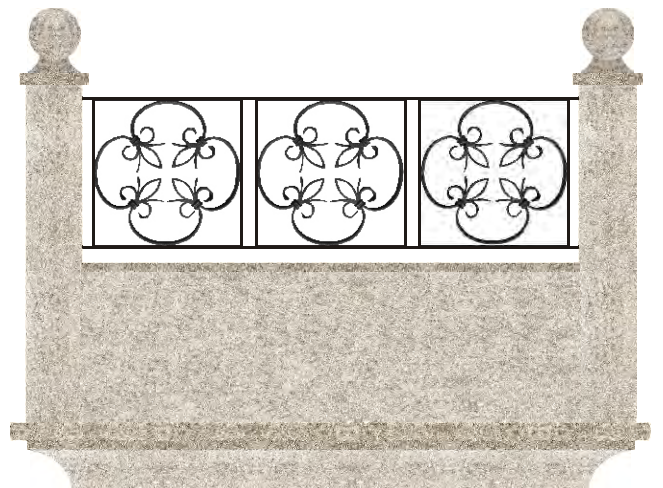

REF.:FPS002;FAD023

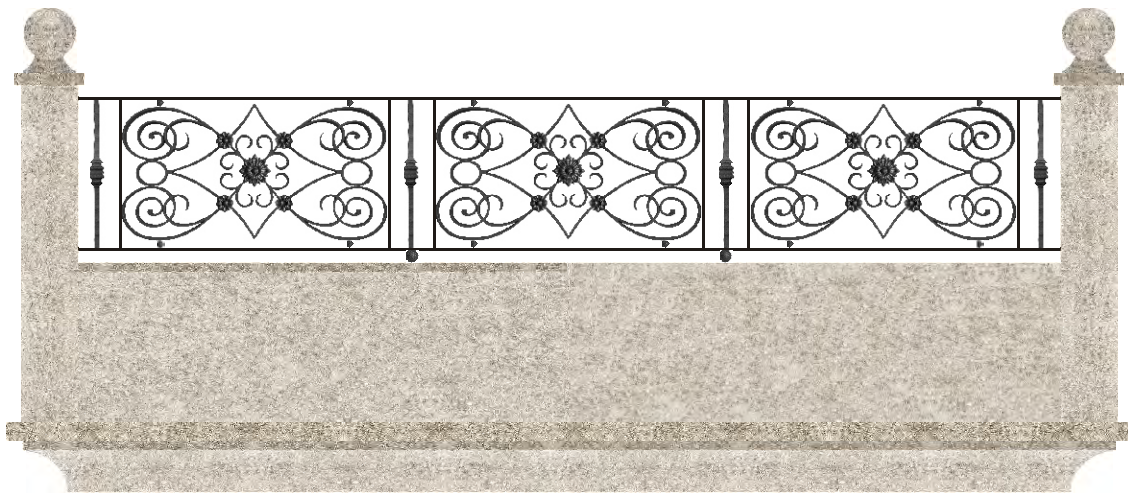

REF.:FPS002;FRE001;FBA024A;FAC006

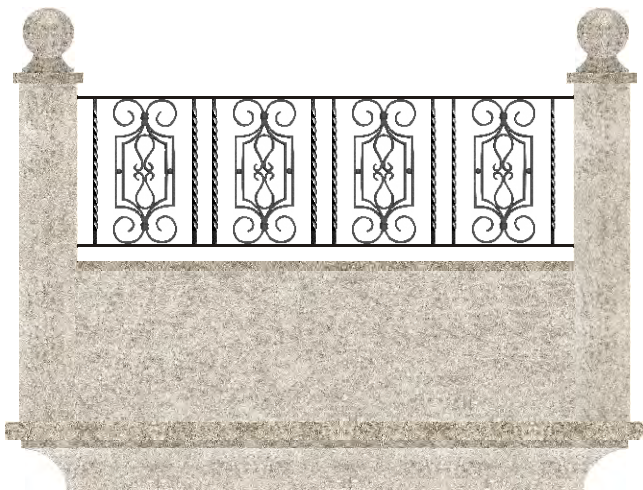

REF.:FPS003;FSO008

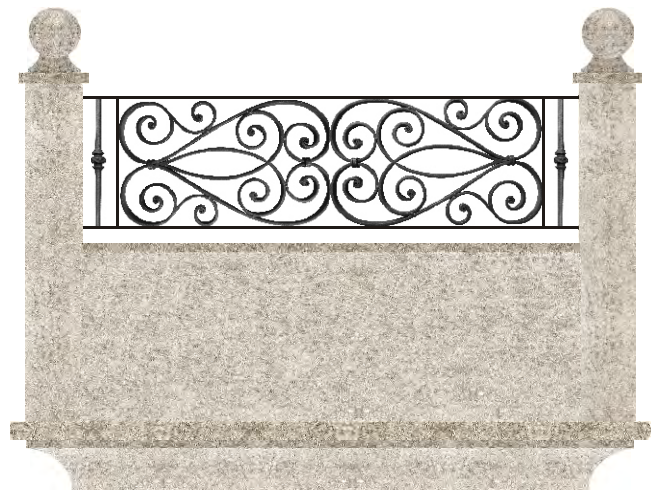

REF.:FPS004;FBA025A;FAC008

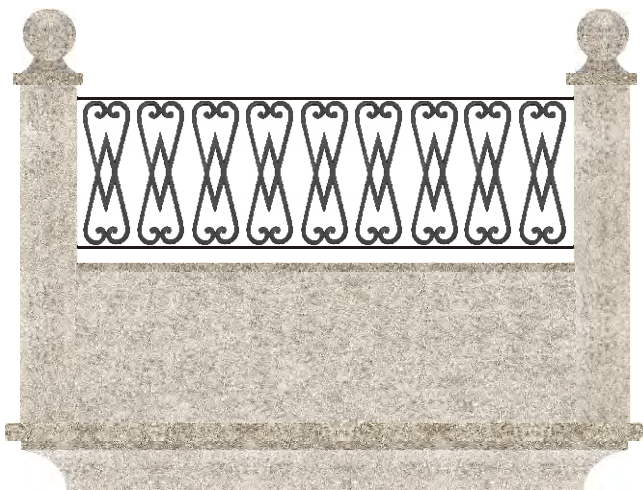

REF.:FPS004;FAD017



REF.:FPS004;FAD016



REF.:AD040;AD044;AD083;MA048;MA044;LAC014;VA105



REF.:AD091;AD092;VA030

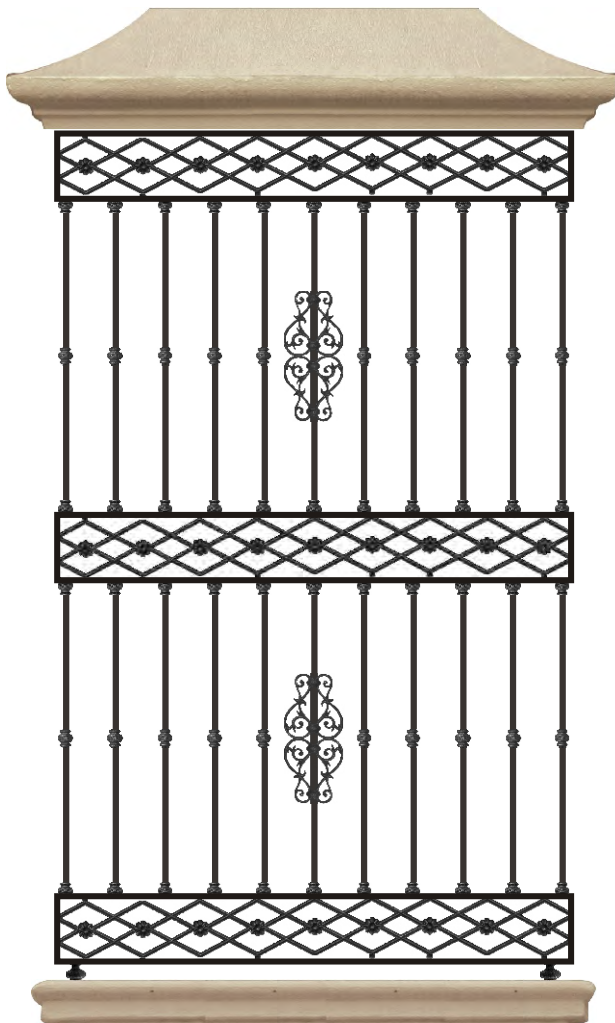

REF.:AD090;MA049;MA050;SO060;RE009

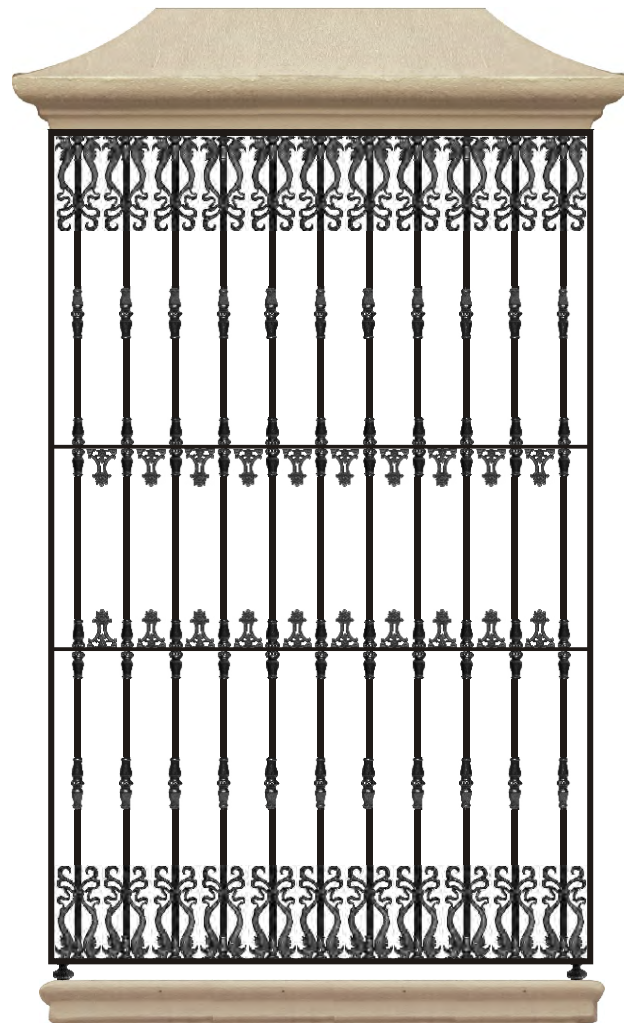

REF.:AD048;AD064;MA030;MA031;RE009H



REF.:AC113;AC114;MA131;AD054;VA030



REF.:SO050;AD042;MA048;MA044;VA029

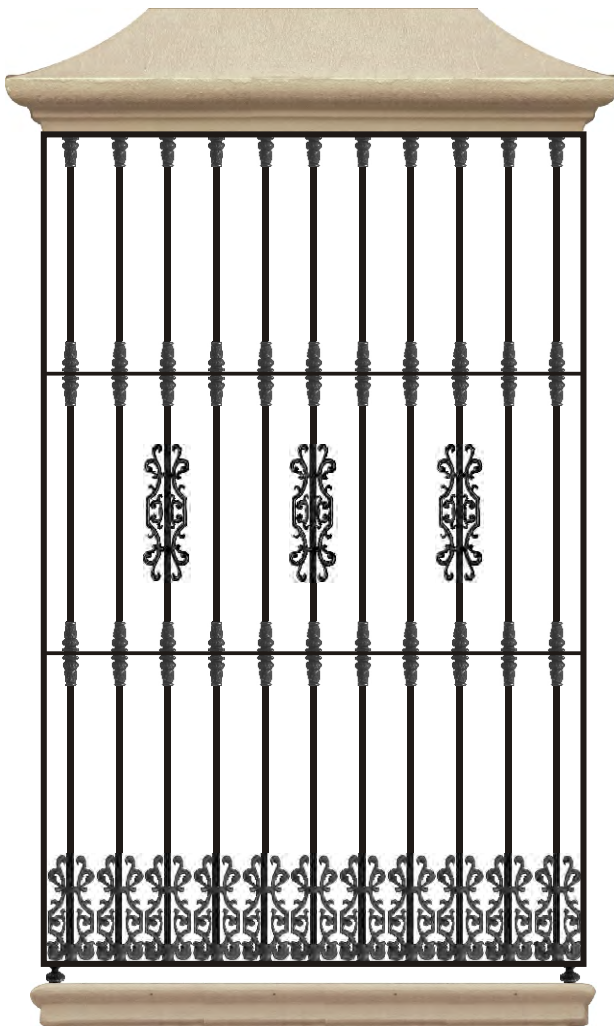

REF.:AD057;AD070;MAP010;RE009

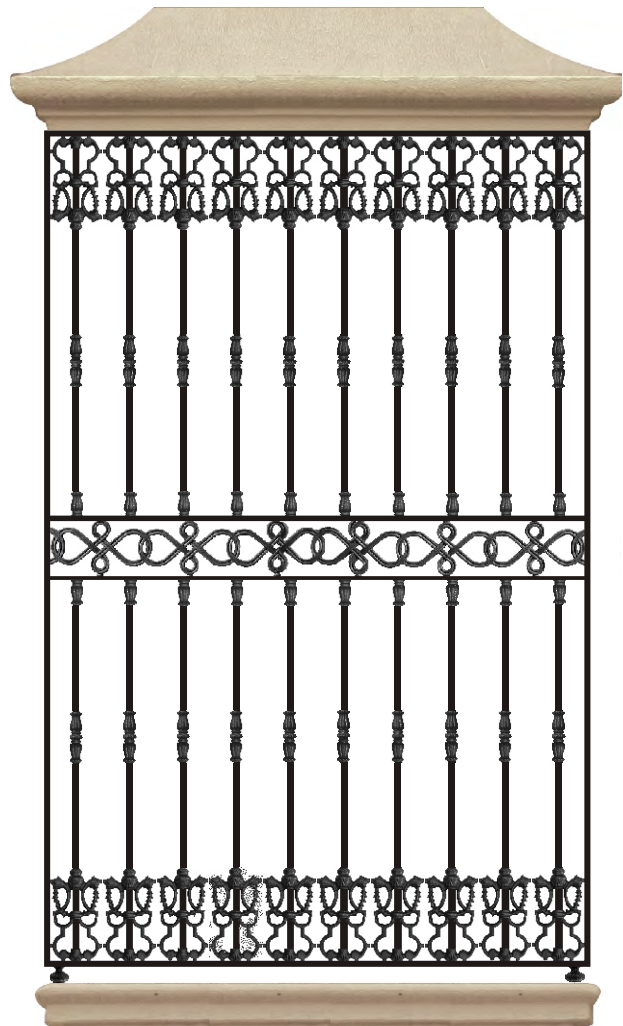

REF.:ADG055;SO055;MA043;MA042;RE009

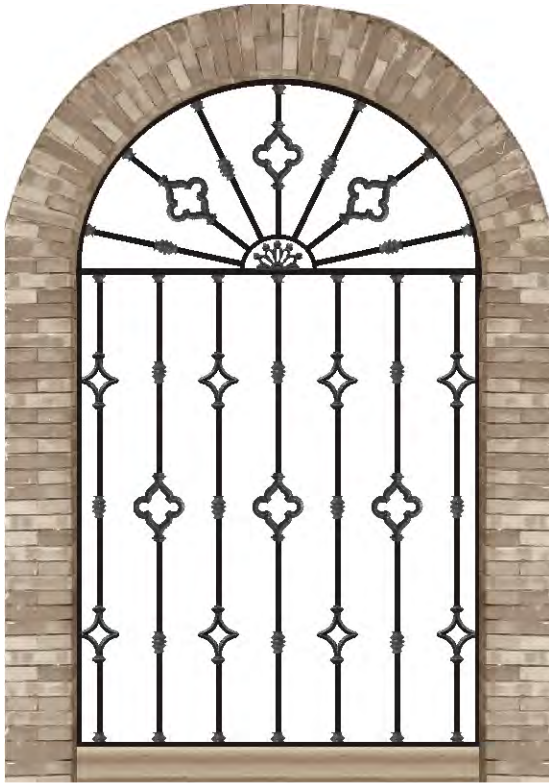

REF.:AD058;AD088;AC032;MA048;MAD048;MA044

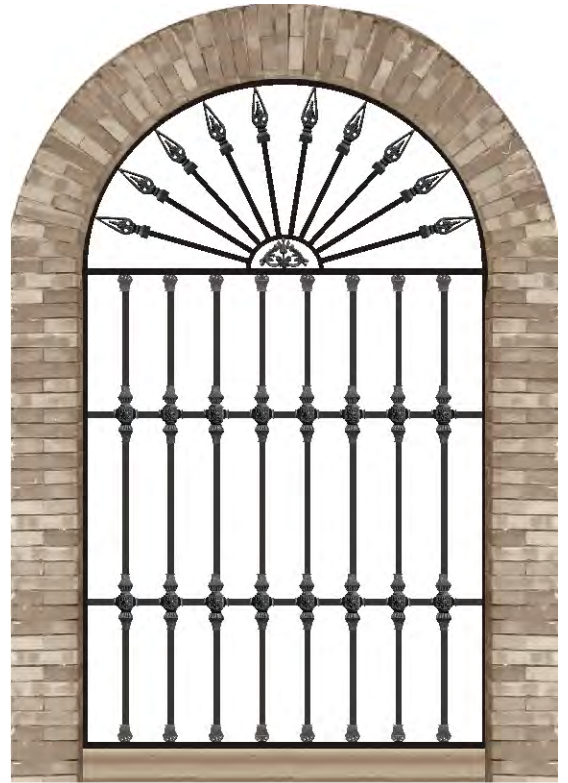

REF.:CR027;LAC013;MA046;VA089

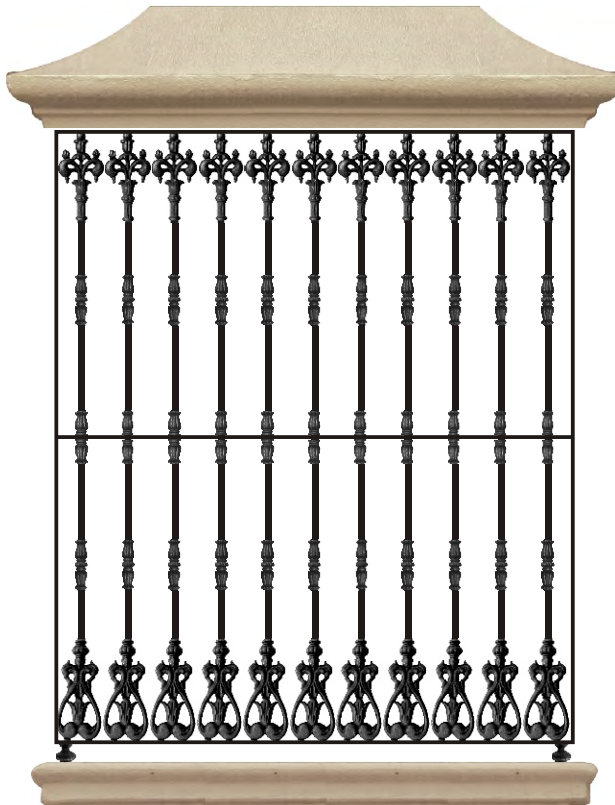

REF.:AC041;AC042;MA042;MA043;RE009H

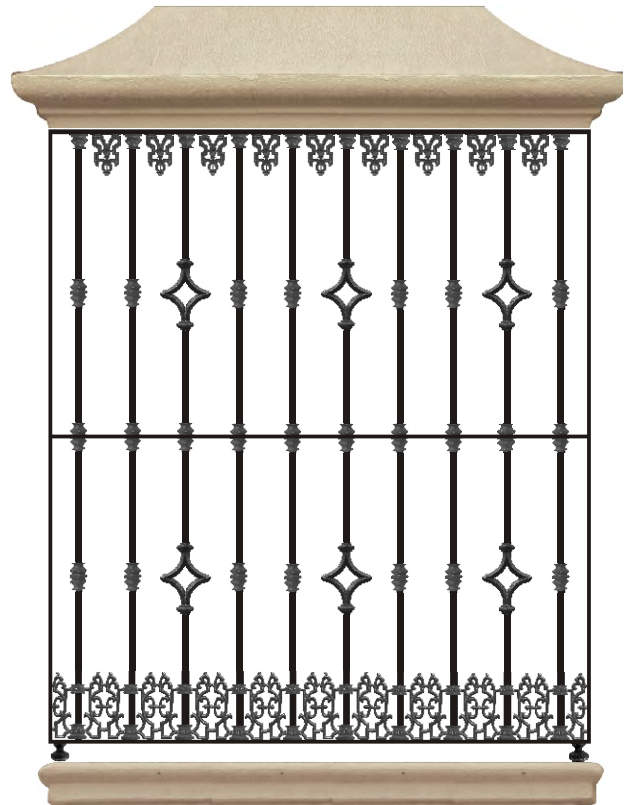

REF.:ADC087;AD088;AD063;MA048;MA044;RE009



REF.:AC028;MA046;MA047;SO060;VA105



REF.:AD056;ADM056;MA046;MA047;VA028;VA030

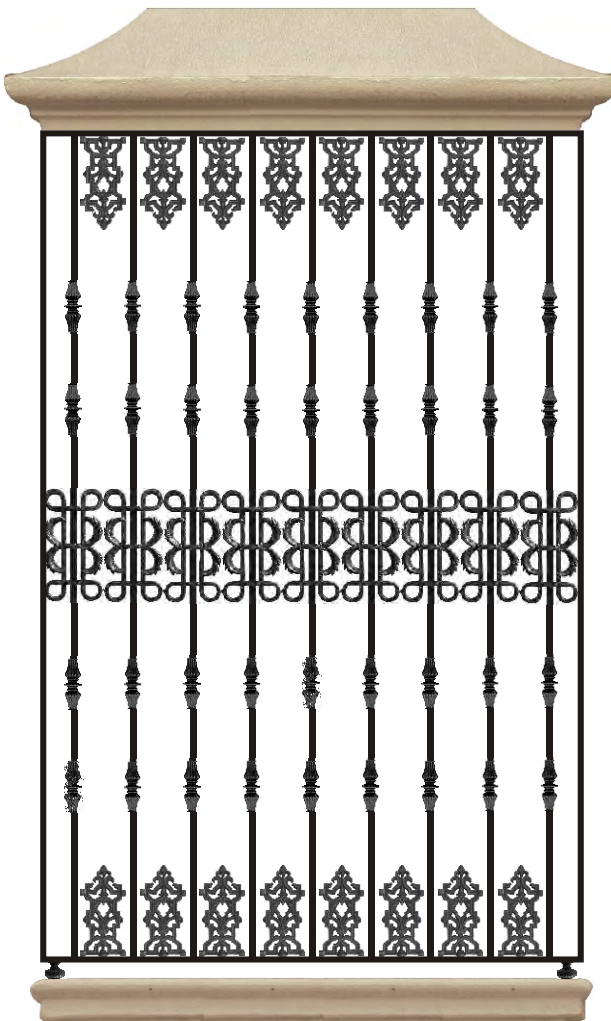

REF.:AD042;AD062;MA012;RE009H

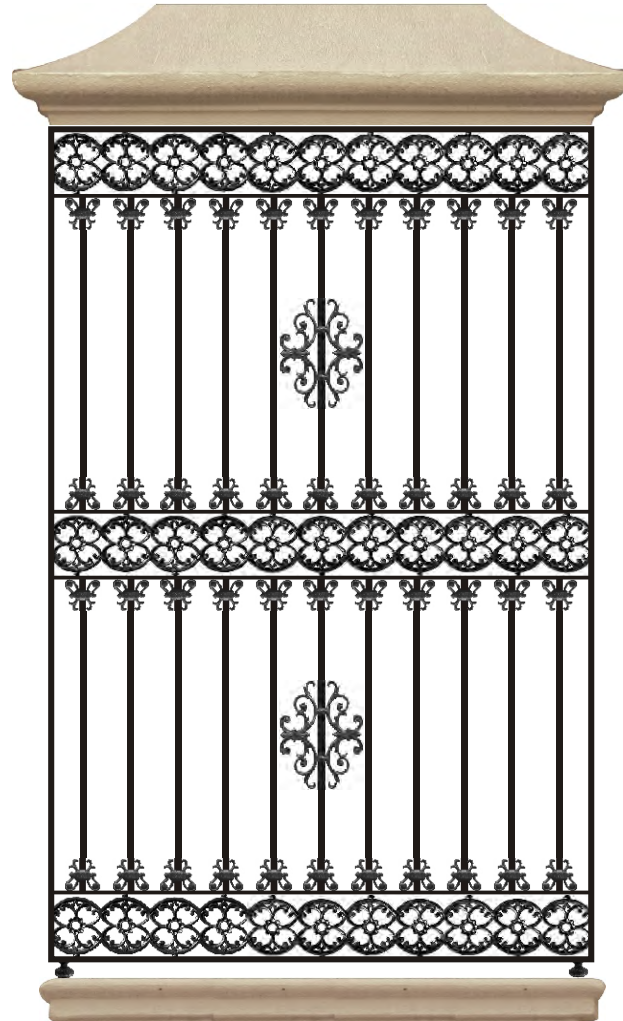

REF.:SO052;MA021;AD043;RE009H



REF.:AD088;AD046;RE009

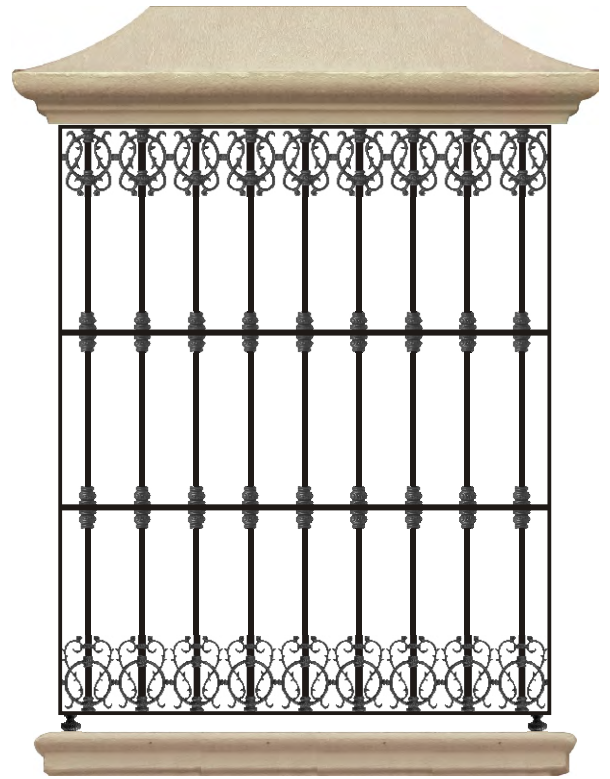

REF.:ADG067;ADP067;MA029;RE009H

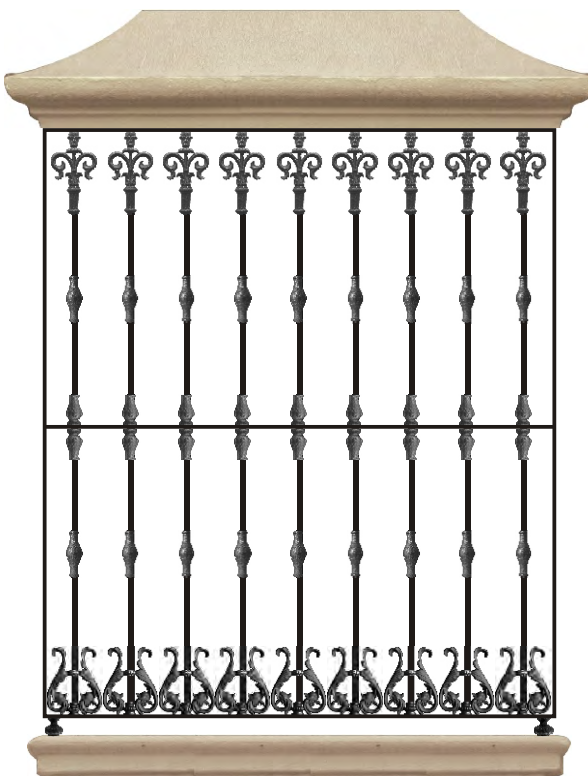

REF.:AD049;AD050;MA039;MA040;RE009

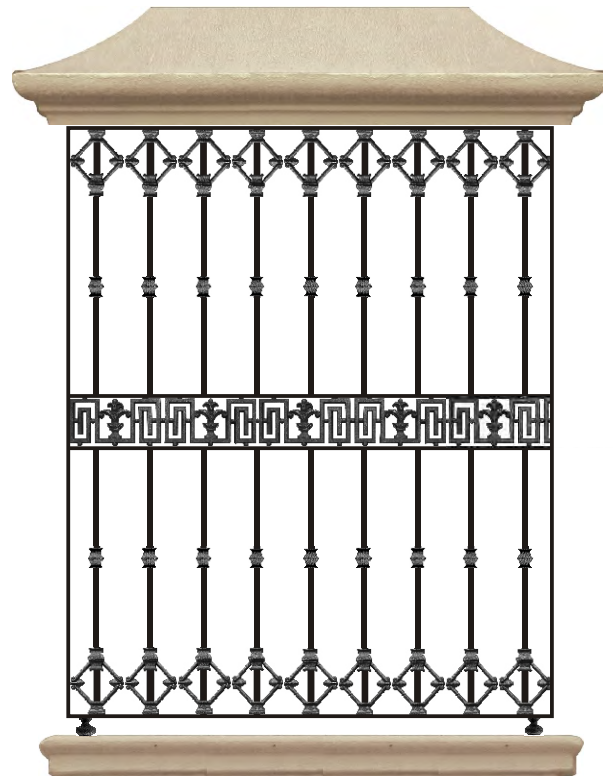

REF.:AD169;SO114;MA128;RE009

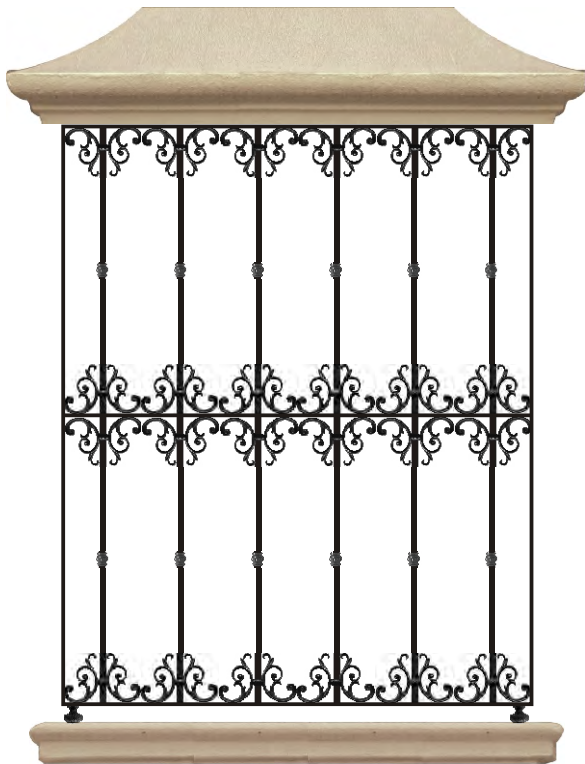

REF.:AD041;MA008;RE009H

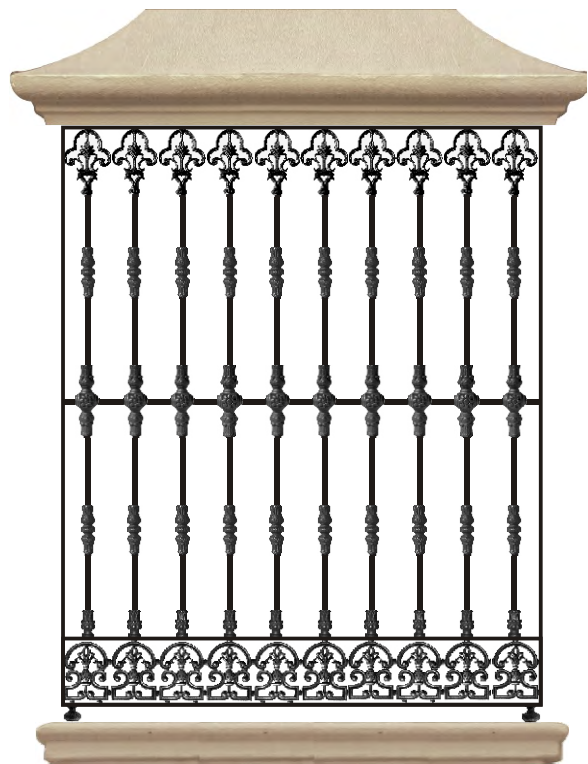

REF.:AD045;SO058;MA005;MA016;CR023;RE009H

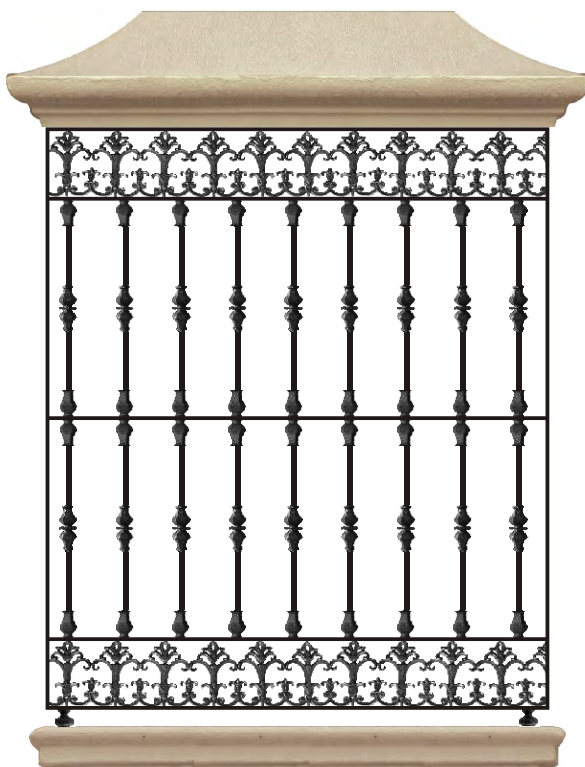

REF.:MA035;MA036;SO054;RE009H

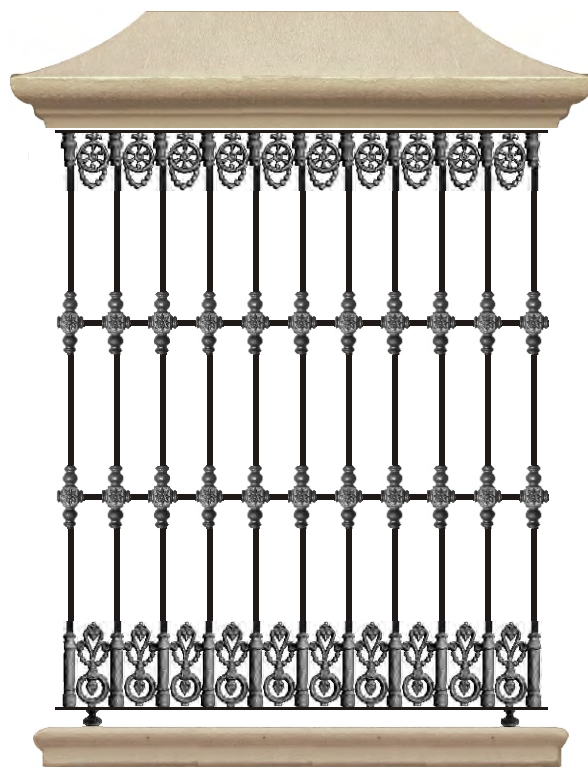

REF.:MA023;MA024;AD059;AD060;CR022;RE009



REF.:AD093C;MA044;RE009



REF.:AD082;MA044;MA048;SO040;RE009

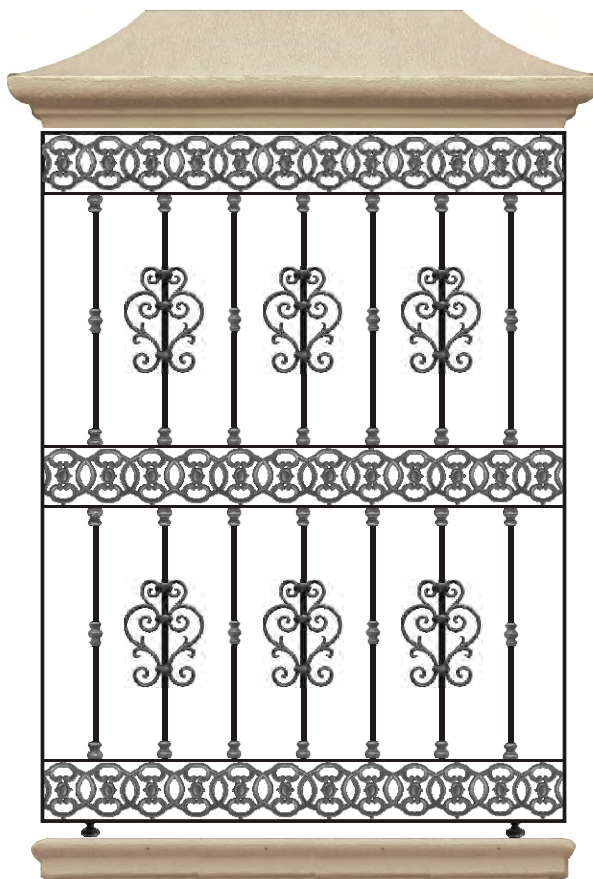

REF.:AD093;MA053;MA054;SO061;RE009

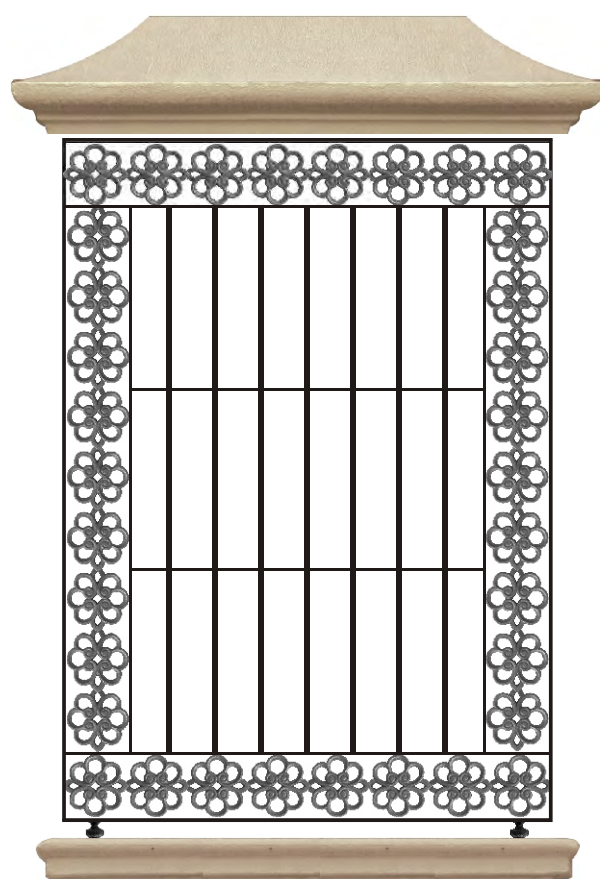

REF.:SO062;RE009;FBP013



REF.:FAD030



REF.:FAD046



REF.:FAD031

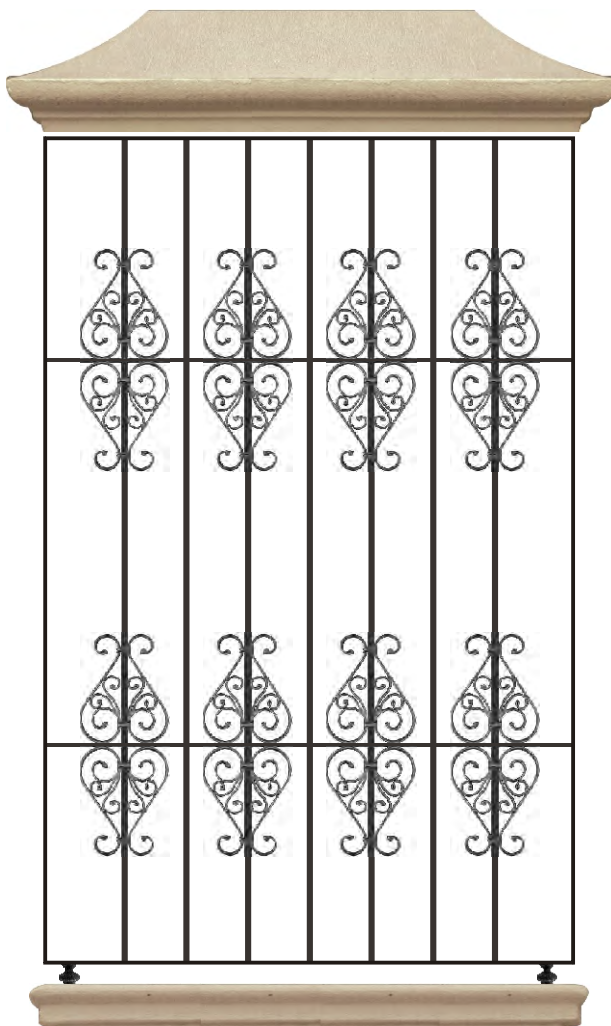

REF.:FAD044;RE009

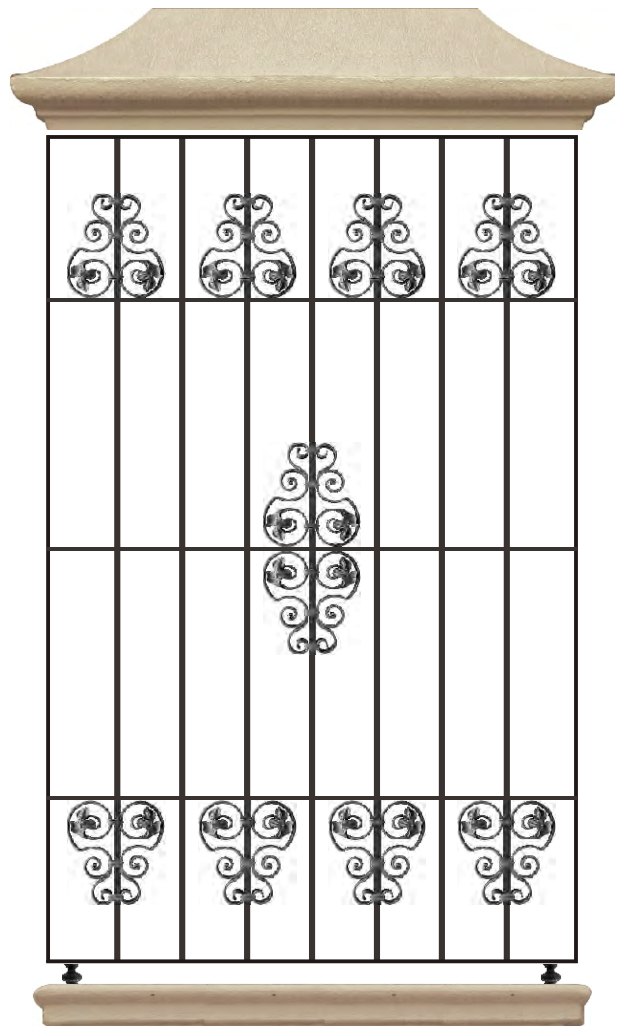

REF.:FAD045;RE009

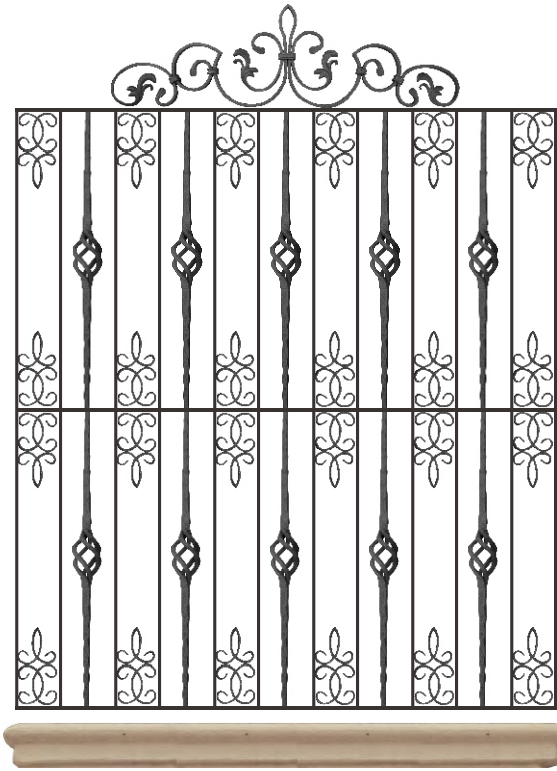

REF.:FBA019A;FAD004;FPE002

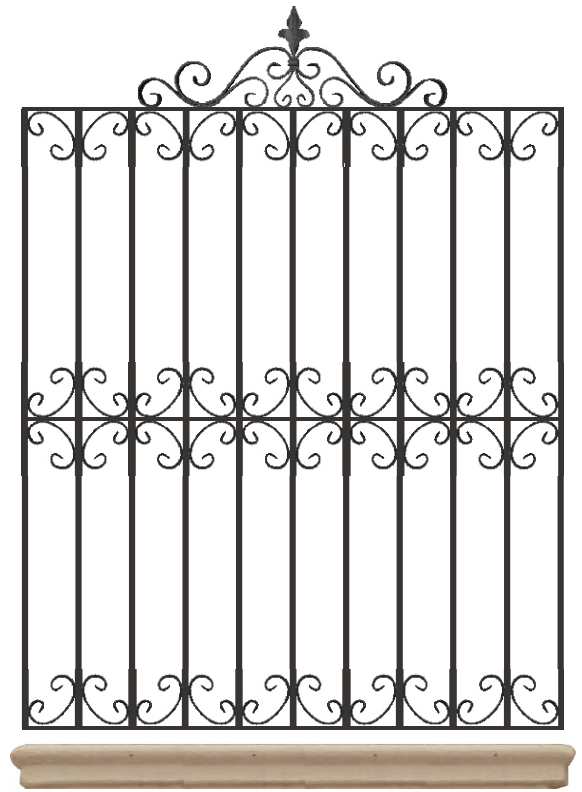

REF.:FC001;FPE003

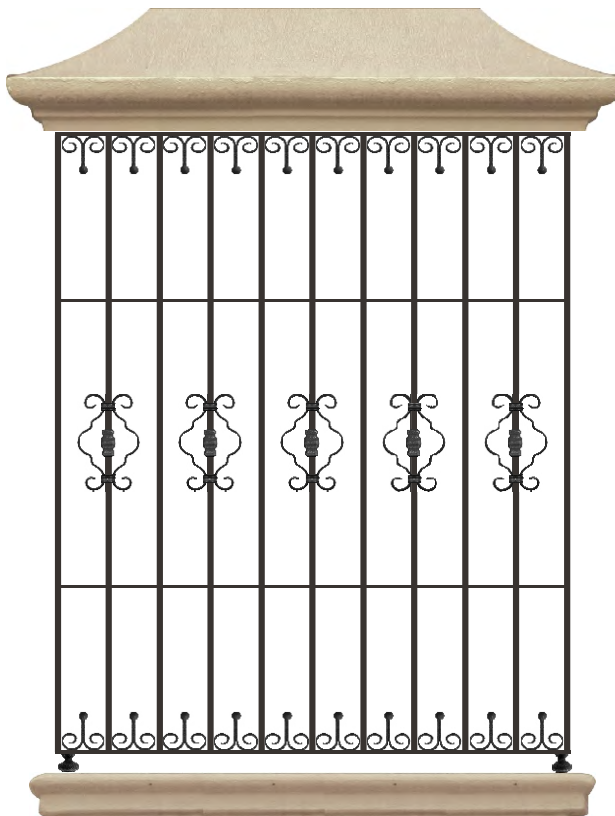

REF.:FE002;FMA055;FLA020;RE009H

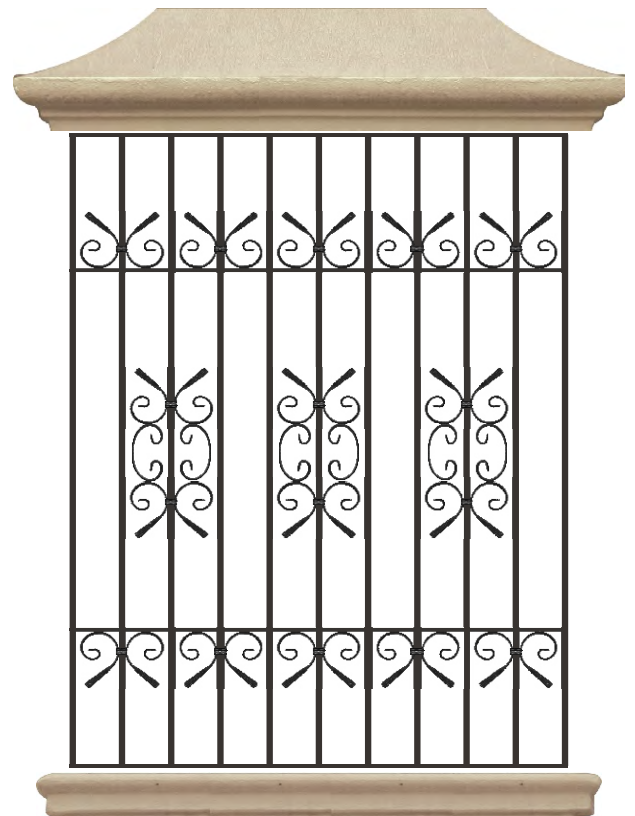

REF.:FL001;FL002;FC001

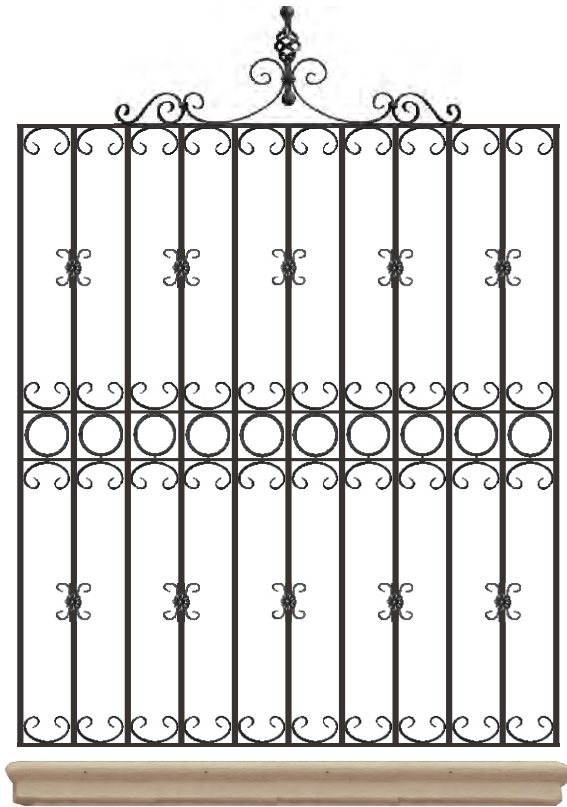

REF.:FAD002;FC003;FVA026;FPE004

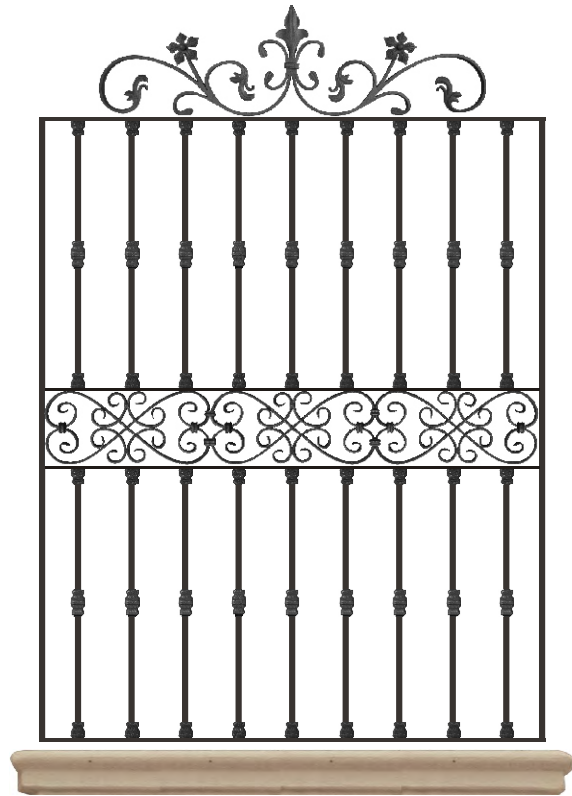

REF.:FMA054;FMA055;FSO001;FPE001

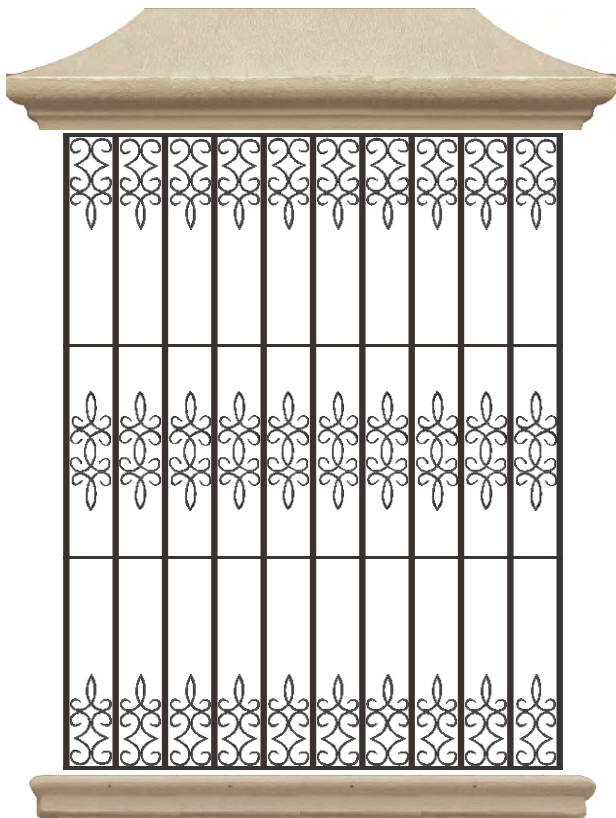

REF.:FAD005;FAD006

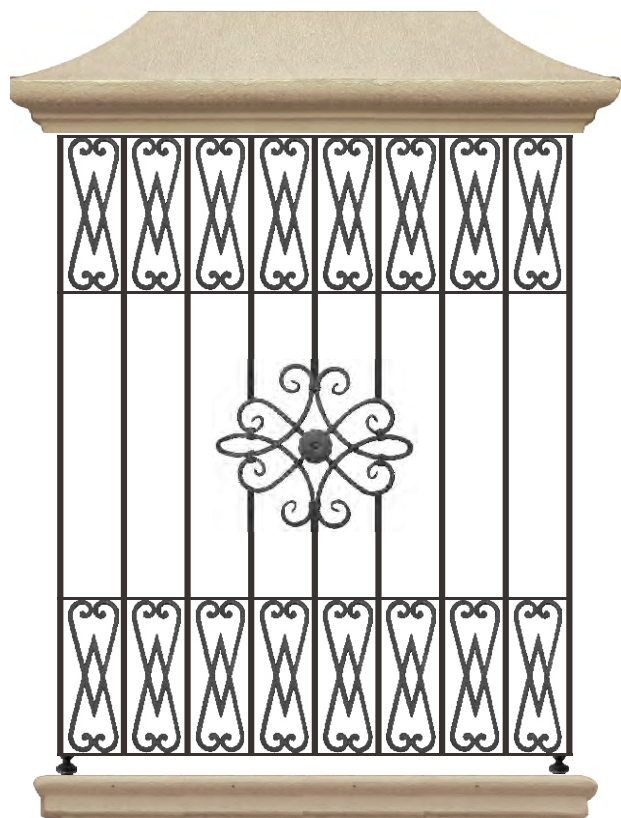

REF.:FAD017;FAD022;RE009H



REJAS / FORJA



REF.:FC004;FS004;FPE002;RE009H



REF.:FAD002;FPE001;RE009H

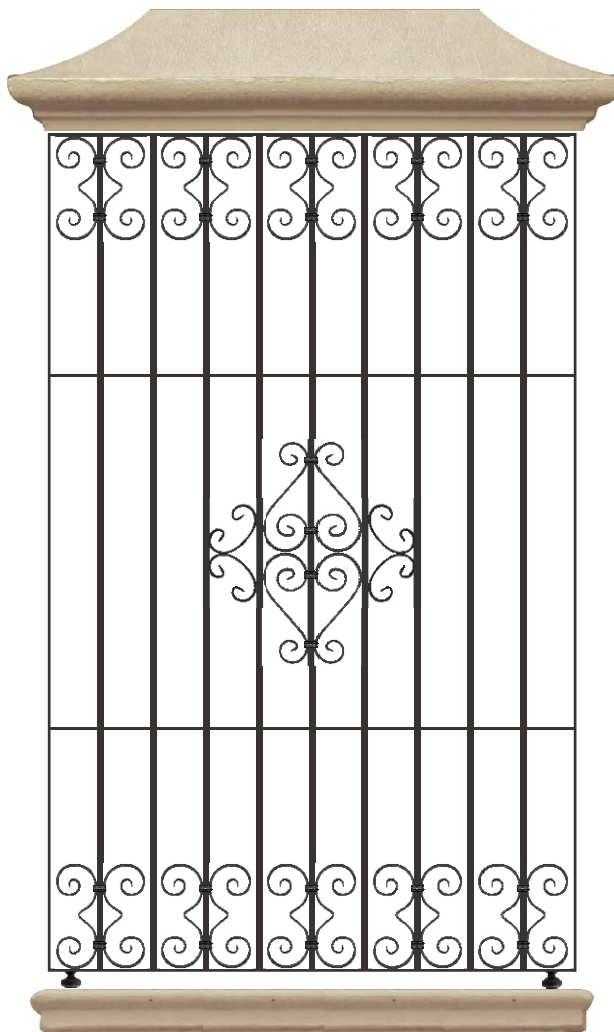

REF.:FE004;FS003;FC001;RE009H

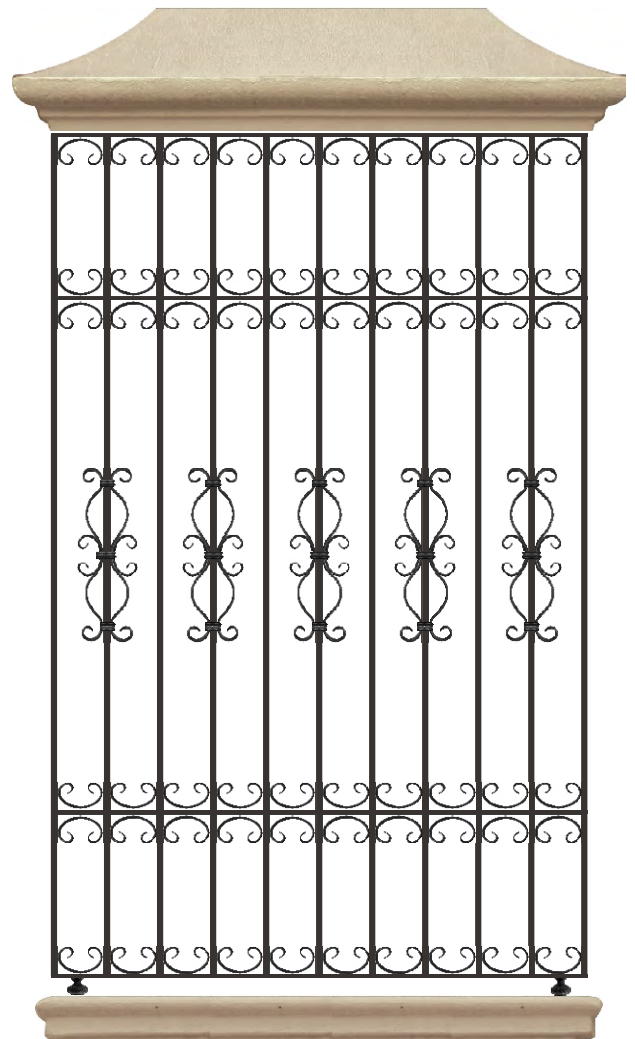

REF.:FC003;FC004;FE003;RE009



REF.:FAD009;FSO010;FPE004;RE009



REF.:FAD003;FAD005;FPE003;RE009H

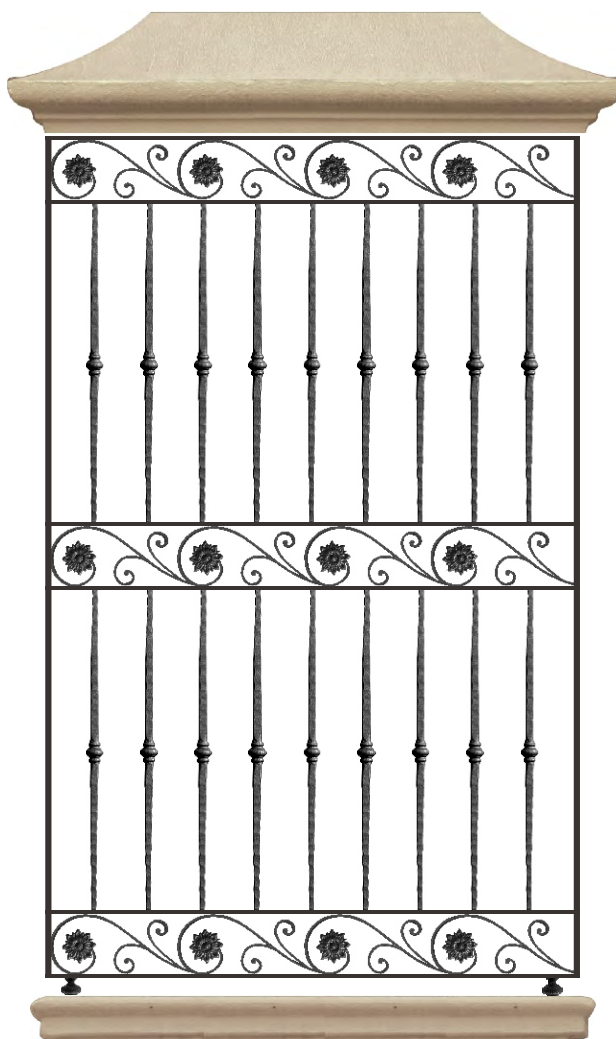

REF.:FBA004A;FAD018;RE009H

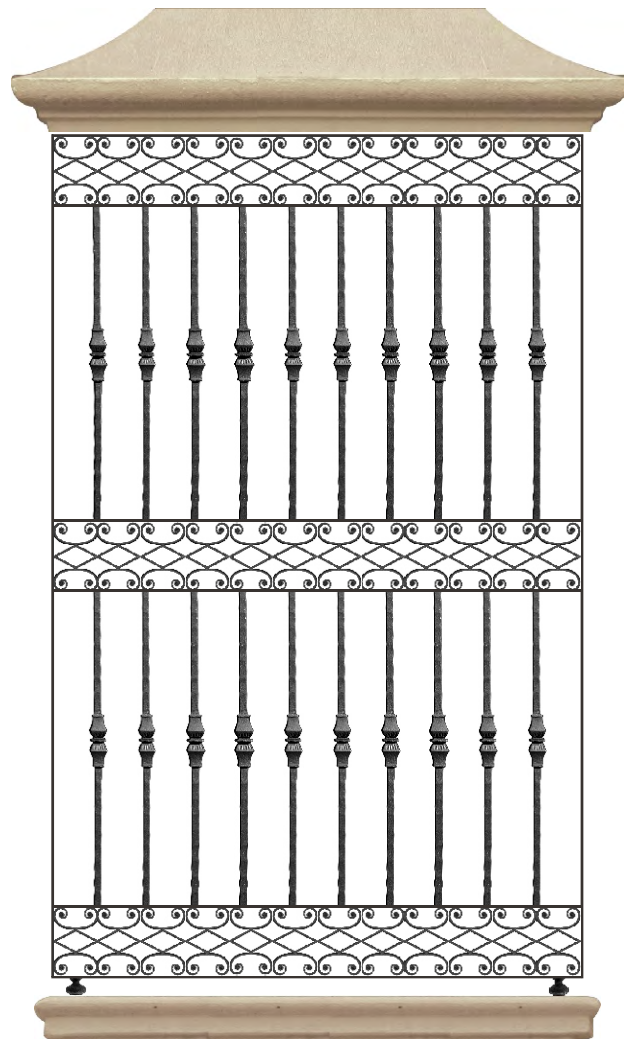

REF.:FBA023A;FSO003;RE009H



REF.:FBA022A;FBA022B;FSO005;RE009



REF.:FBA004A;FVA010;RE009

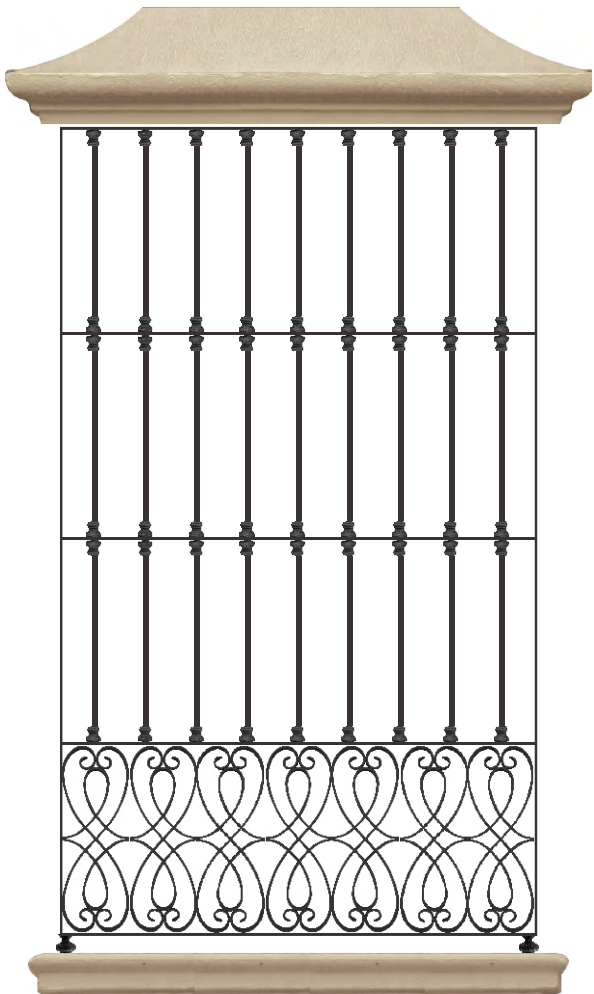

REF.:FAD016;FMA050;RE009

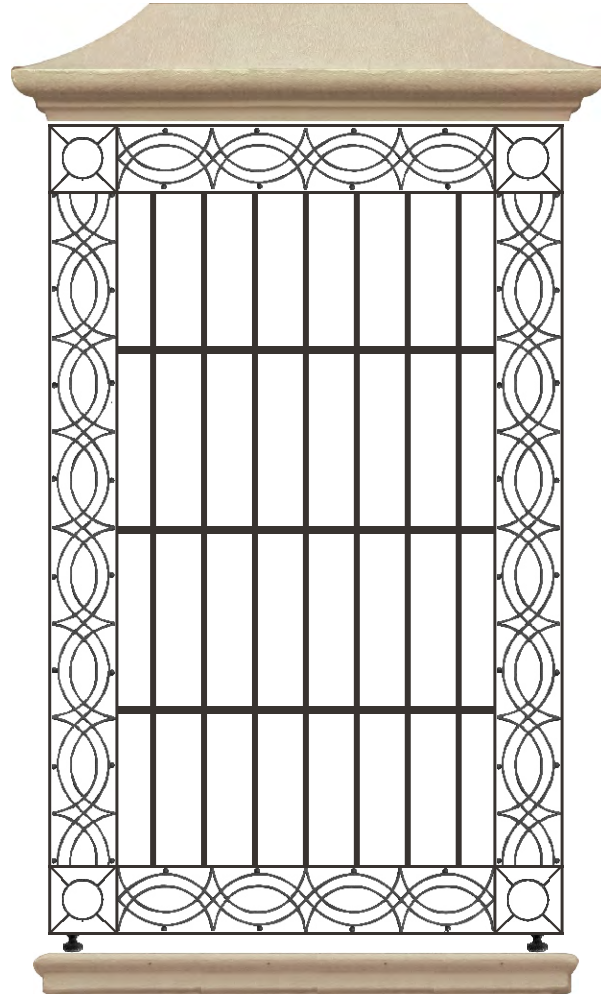

REF.:FBP003;FSO006;FVA026;RE009



REF.:FAD008;FSO009;RE009H



REF.:FLA019;FLA020;RE009H

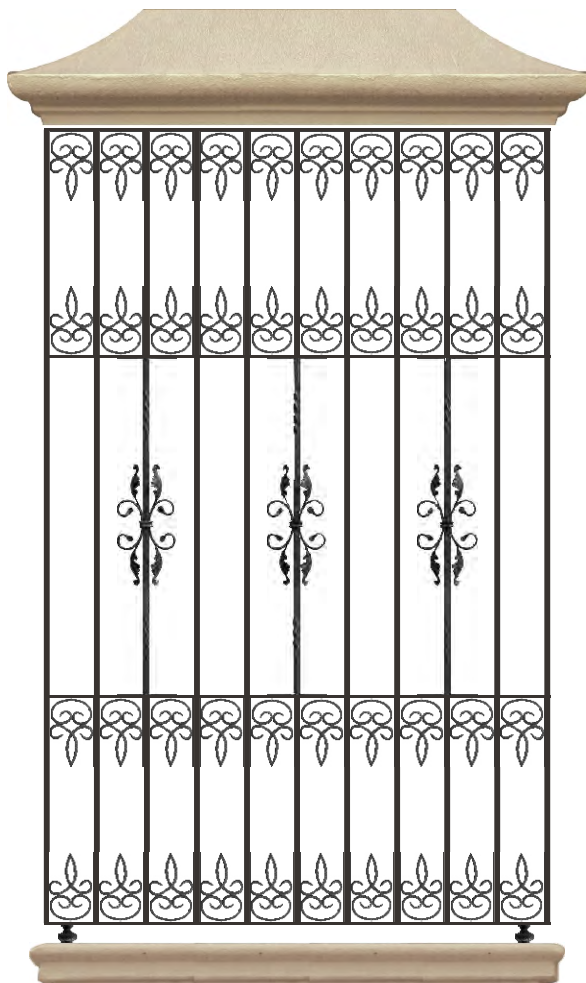

REF.:FBA007/16;FAD003;RE009

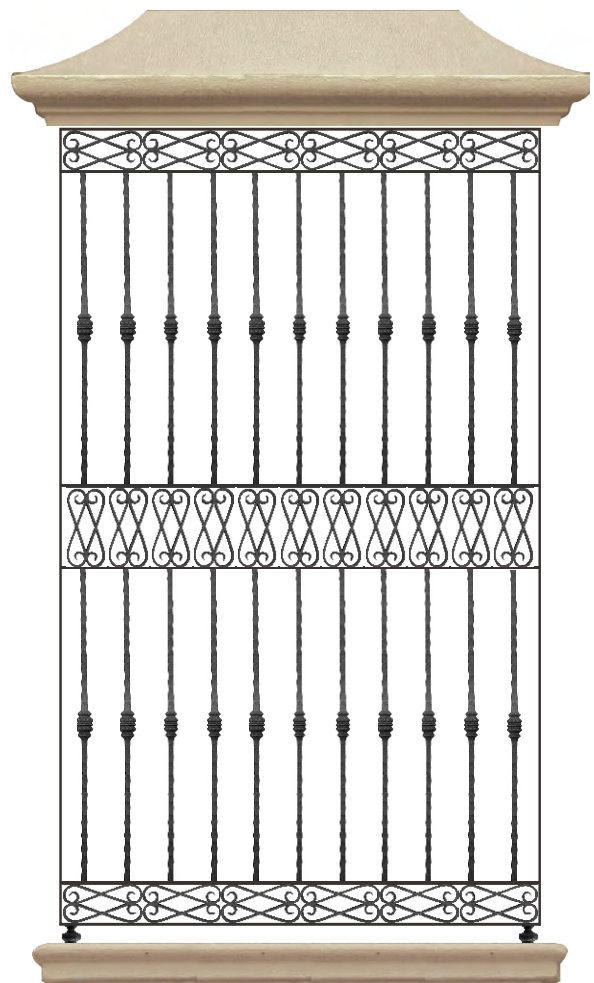

REF.:FBA024A;FAD015;RE009H



REF.:FAC007



REF.:FAD023



REF.:FAD024

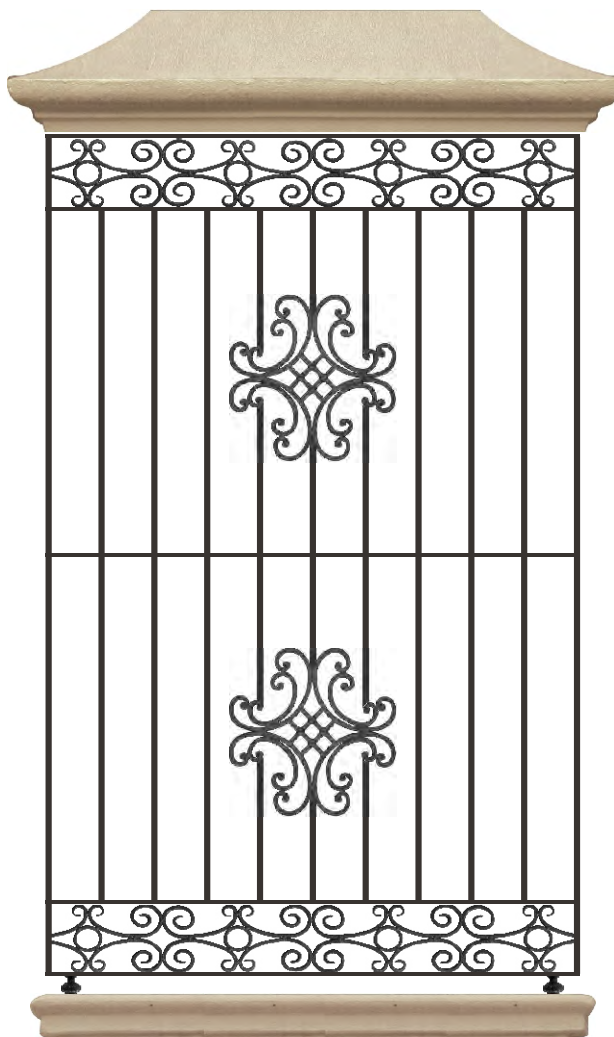

REF.:FAD025;FSO007;RE009

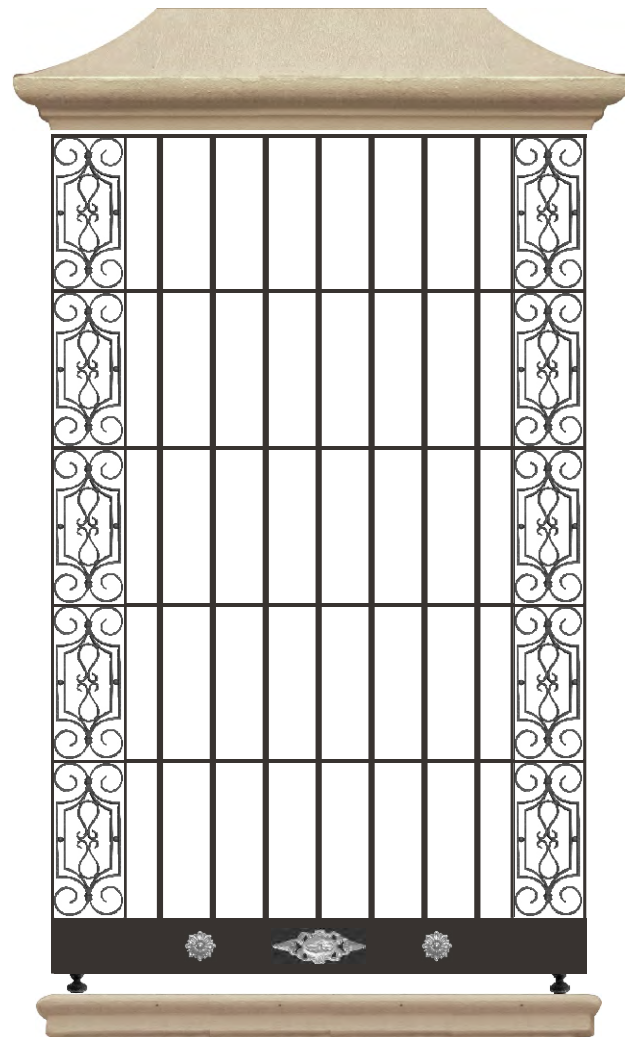

REF.:FSO008;FVA023;VA074;RE009



REF.:FAD025

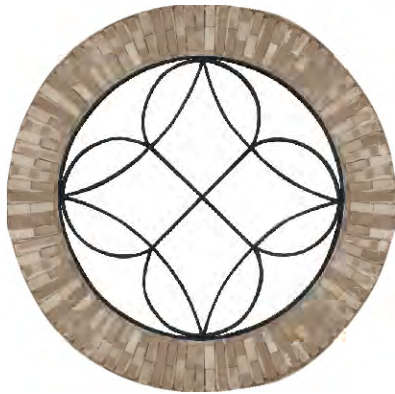

REF.:FAD020



REF.:FAD021



REF.:FBP006;FAD007;LAC014

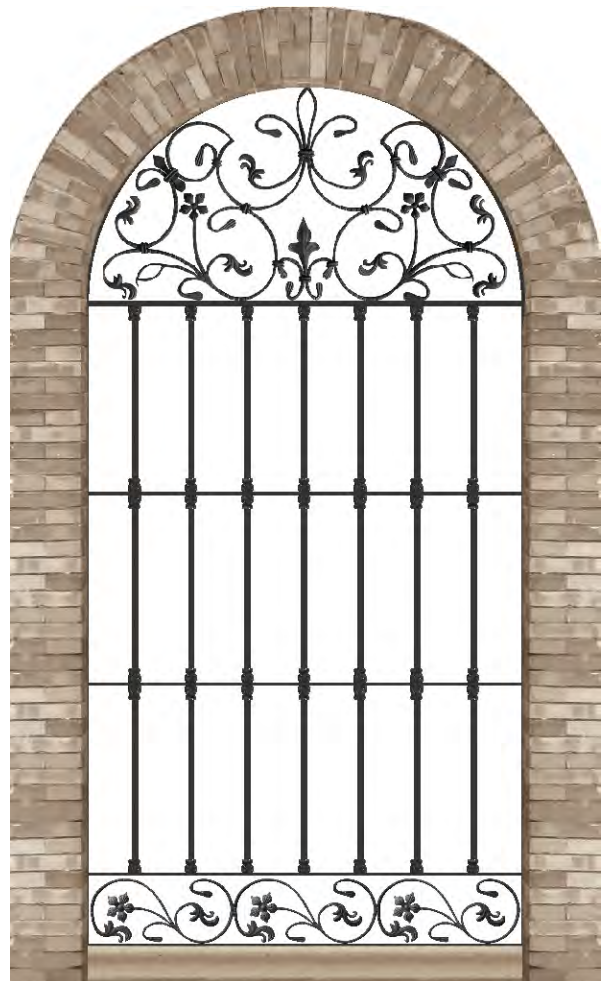

REF.:FAC001;FAC004;FMA054

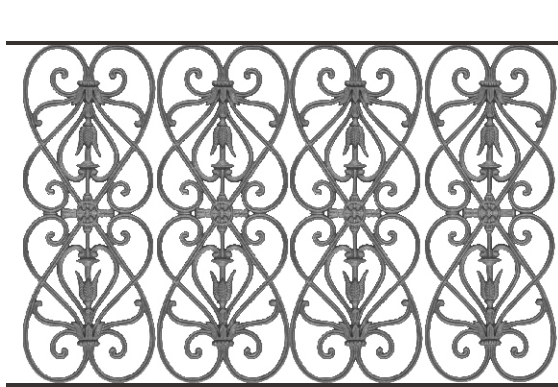

REF.:AC061;AR032



REF.:AC058;AR024;RE014R;BS002



REF.:AR025;RE010;BS002;AC003

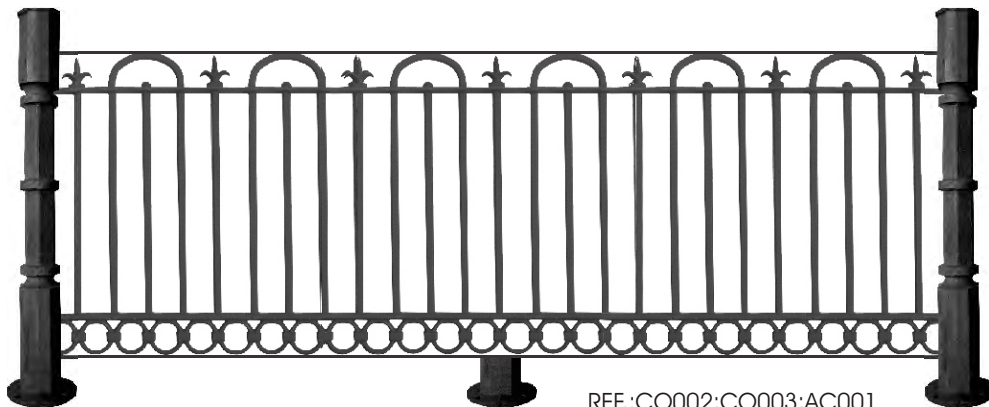

REF.:CO002;CO003;AC001

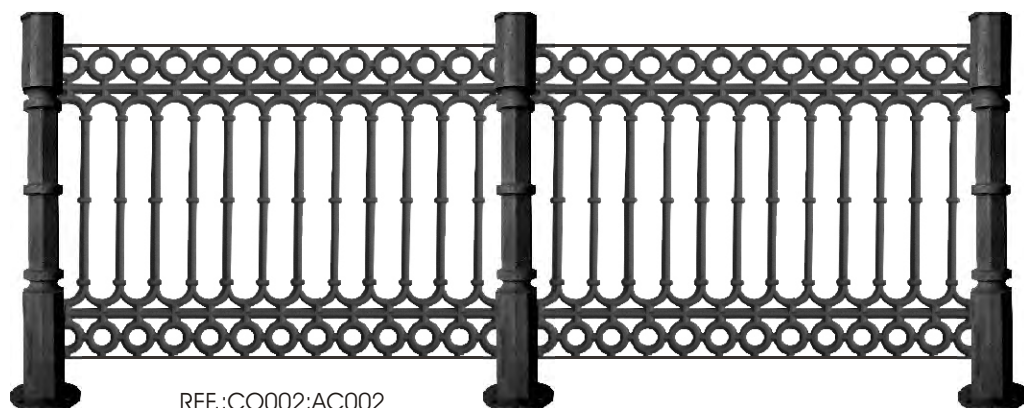

REF.:CO002;AC002

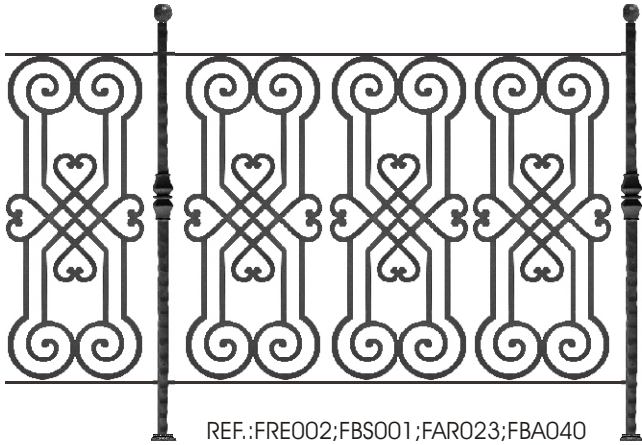

REF.:FRE002;FBS001;FAR023;FBA040

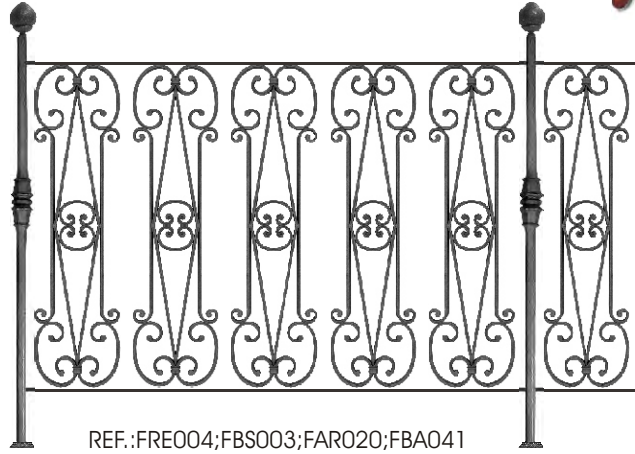

REF.:FRE004;FBS003;FAR020;FBA041

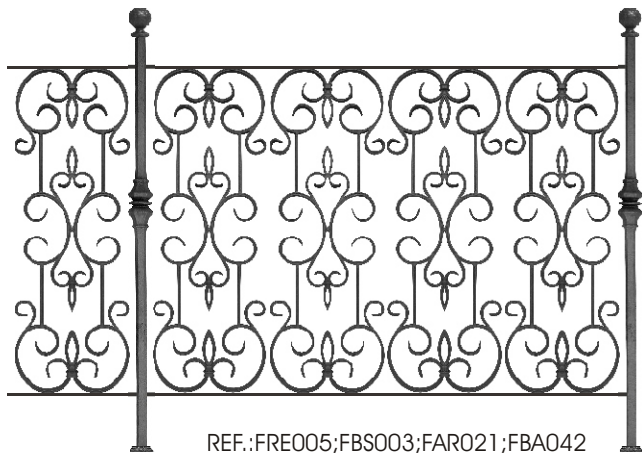

REF.:FRE005;FBS003;FAR021;FBA042

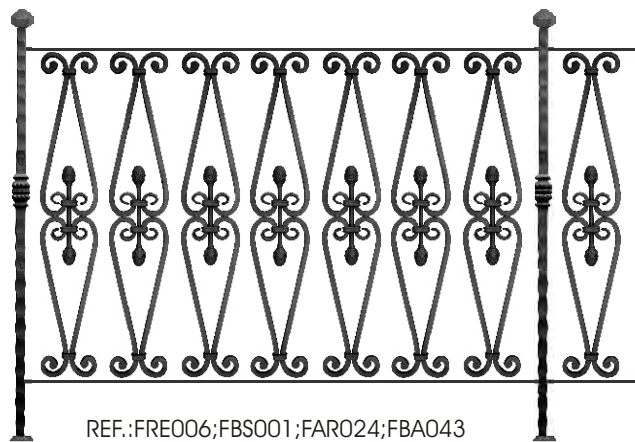

REF.:FRE006;FBS001;FAR024;FBA043

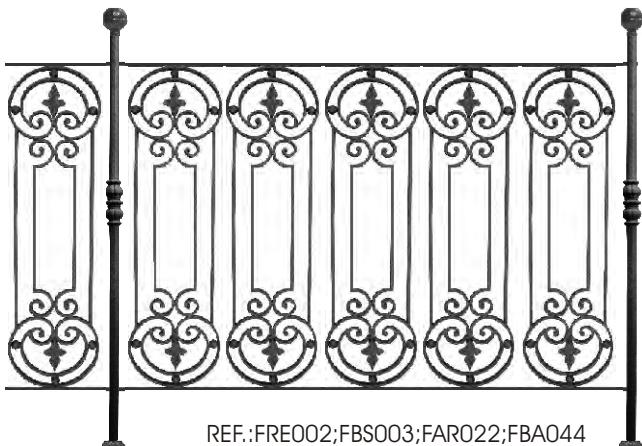

REF.:FRE002;FBS003;FAR022;FBA044

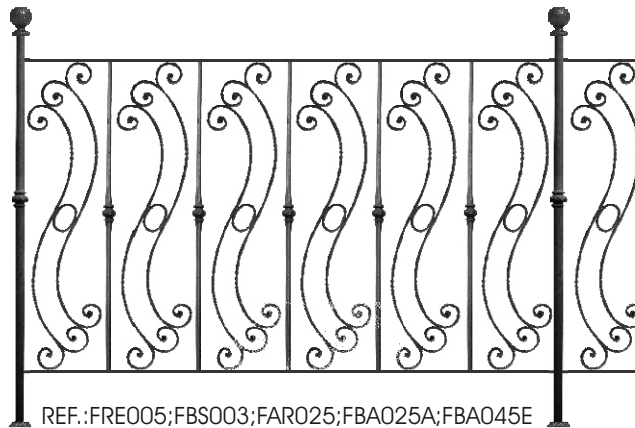

REF.:FRE005;FBS003;FAR025;FBA025A;FBA045E



REF.:FBA088;FBS001;FAR001;FRE004

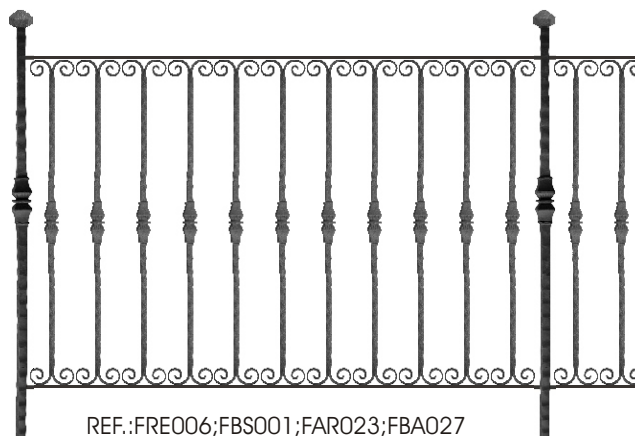

REF.:FRE006;FBS001;FAR023;FBA027



REF.:MA044;MA048;MAD048;AD092;SO046;RE009

REF.:AD042;AD052;MA044;MAD048;SO059;RE009



REF.:BA104900;MA131;MA132;LA027;RE009

REF.:AD092;MA044;MA048;LAC013;FRE00150



REF.:RE021R;AR027;BA017700;SO060;LA012B

REF.:RE022;AR025;BA029;LAC014;RE009



REF.:ADC043;ADC041;MA048;MAD048;LAC013;RE009

REF.:ADC087;AD083;MA048;MAD048;LAC014;RE009



REF.:AD054;AD053;MA042;MA043;LA026;RE009

REF.:AD088;AD046;VA028;LA014;RE009



REF.:RE014R;AR030;CR025;CR026

REF.:RE010R;AR025;LA023;BA062;BA027;SO055;RE009



REF.:AD057;MAD010;LA013;RE009

REF.:AD058;AD088;MA048;MAD048;LAC014;RE009



REF.:AD040;AD044;MA030;MA031;LA024;RE009

REF.:ADG067;MA021;MA029;LA025;RE009



REF.:RE014R;AR024;BA060;SO058;LA027;RE009

REF.:RE010R;AR025;SO053;BA066;LA013;RE009



REF.:FBA012A;FBA085;FLA020

REF.:FPS002;FAD045;LAC029

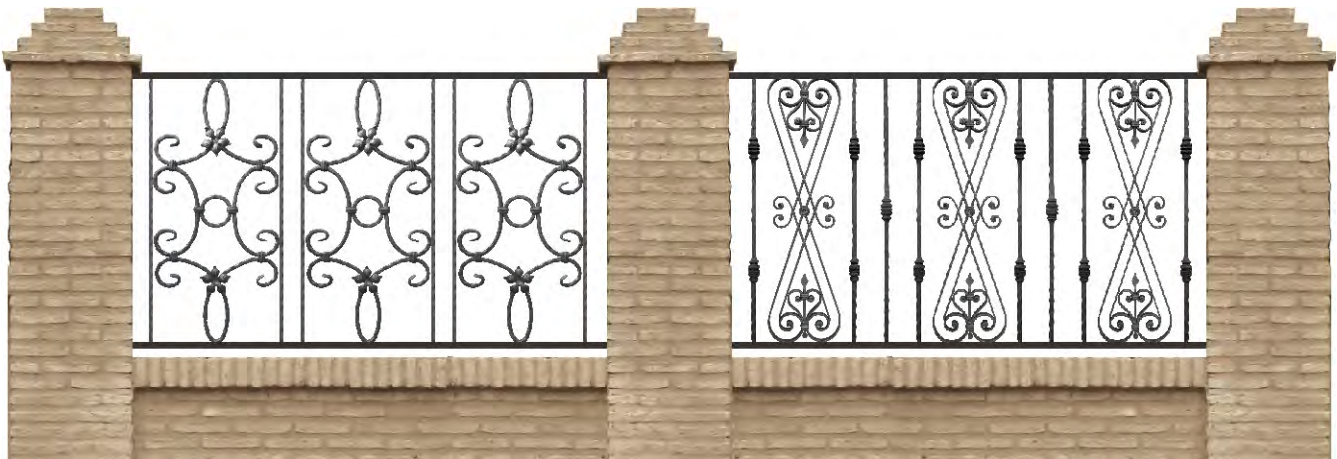

REF.:FAD032;FPS005

REF.:FBA024A; FBA024B; FBA087



REF.:FBA054A;FBA054B;FRE001

REF.:FBA057A;FBA057B;FRE001



REF.:FE001;FLA002;MA044;MA045;MA048

REF.:FBA036;FBA014A;FLA003



REF.:FAD005;FLA012;MA044;RE009

REF.:FC004;FE004;FLA021;REH009

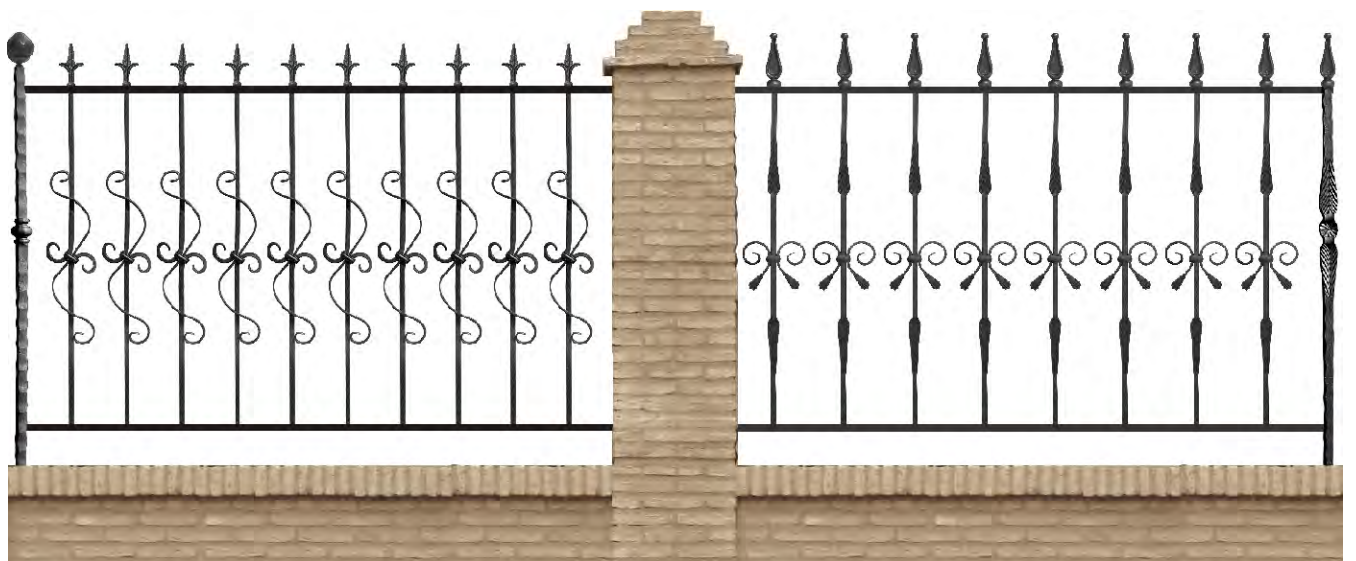

REF.:FRE004;FAR004;FBA034;FLA012

REF.:FAR002;FBA033;FLA008

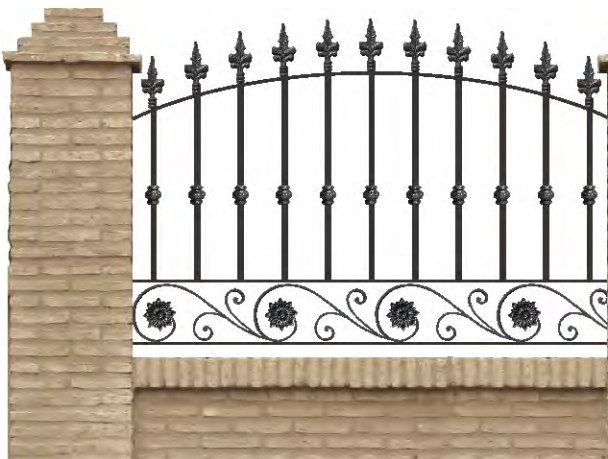

REF.:FAD018;FPS002;FMA053;FLA004

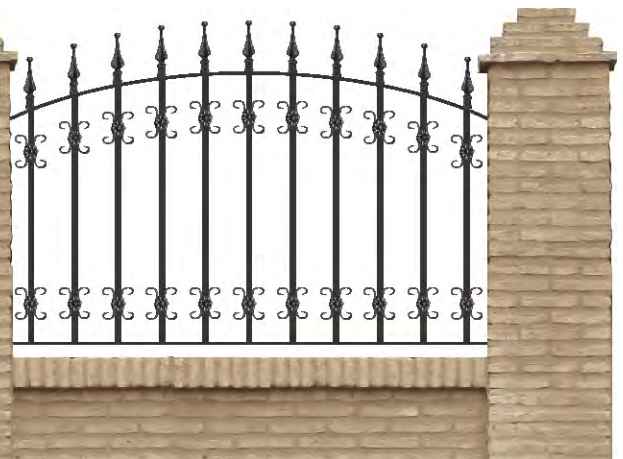

REF.:FAD002;FPS003;FLA006



REF.:FBA019A;FAD025;FPS005;FLA018

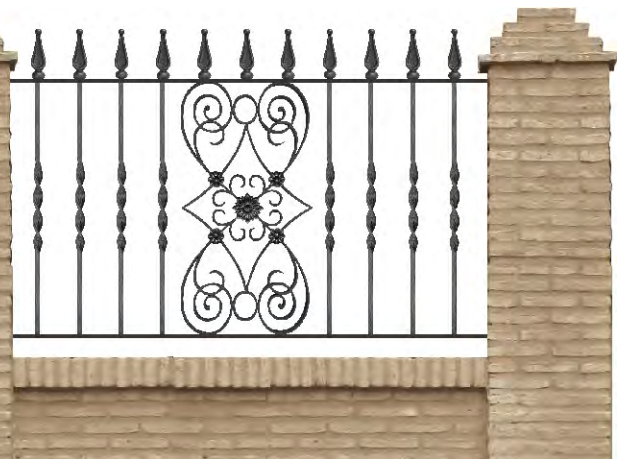

REF.:FBA016A;FAC006;FLA008



REF.:FRE004;FAR016;FBA016B;FSO005;FLA015

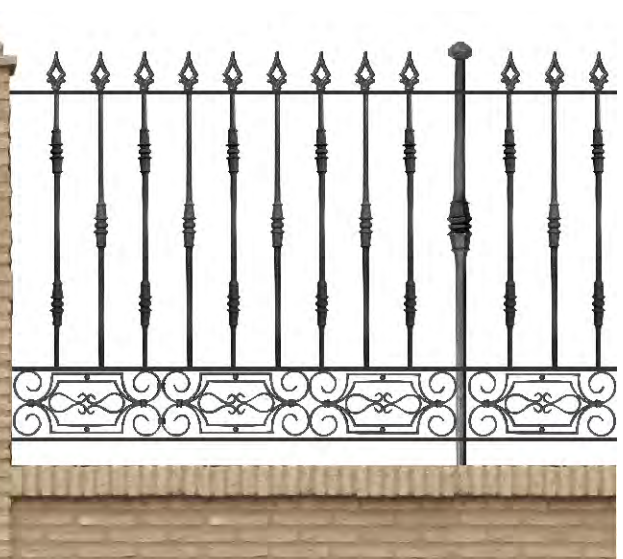

REF.:FRE006;FAR020;FBA020A;FBA020B;FSO008;FLA017



REF.:FBA017A;FBA035;FLA017

REF.:FBA021A;FBA051;FAD018



REF.:FC002;FS002;FLA006;RE009

REF.:FBA001A;FBA043;FLA015;RE009



REF.:FAR022;FBA022A;FS0001;FLA001

REF.:FRE006;FAR012;FBA012B;FS0002;FLA007



REF.:FAD004;FAD010;FPS002;FLA020



REF.:FAD003;FPS002;FLA003



REF.:FAC007;FC003;FLA003;REH009



REF.:FAD008;FSO009;FLA009;REH009

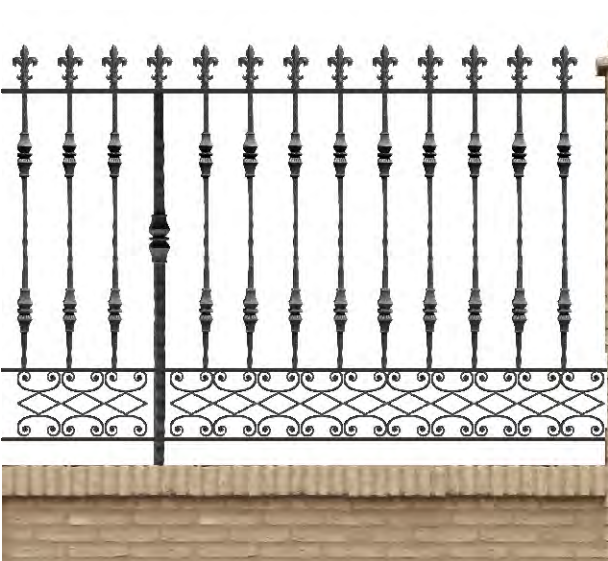

REF.:FAR023;FBA023B;FSO003;FLA011

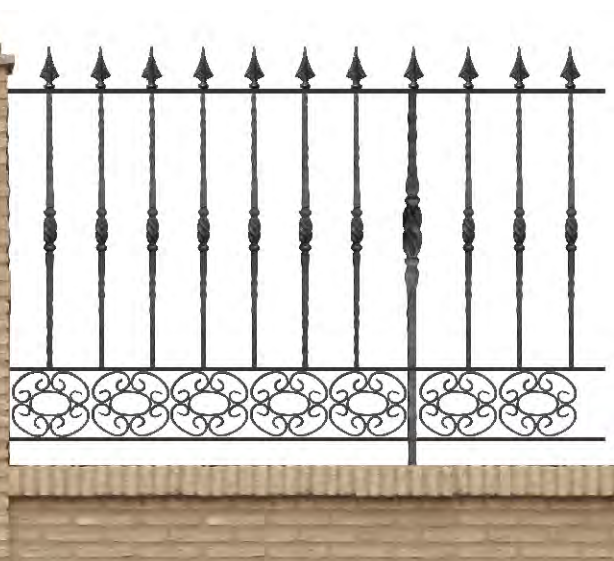

REF.:FAR013;FBA013A;FSO004;FLA003



REF.:FBA007;FBA024A;FBA052;FS003

REF.:FAD014;FMA055;FLA004



REF.:FBA025B;FSO006;FLA017;RE009

REF.:FC004;FE003;FMA054;FLA016;REH009



REF.:FRE001;FBA021A;FAD019;LA030

REF.:FRE001;FC004;FVA026;FLA014



REF.:FAD007;FPS002;FLA019;FLA006

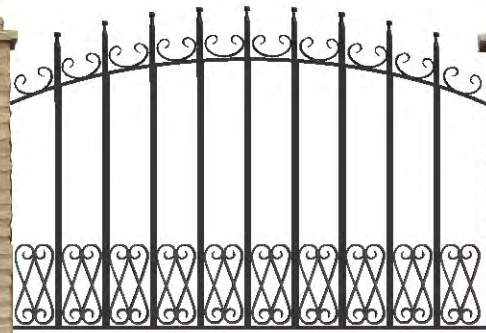

REF.:FAD015;FC004;FPS002;FLA014



REF.:FBA015A;FBA039;FPE003;REH009



REF.:FE002;FMA055;FPE002;RE009

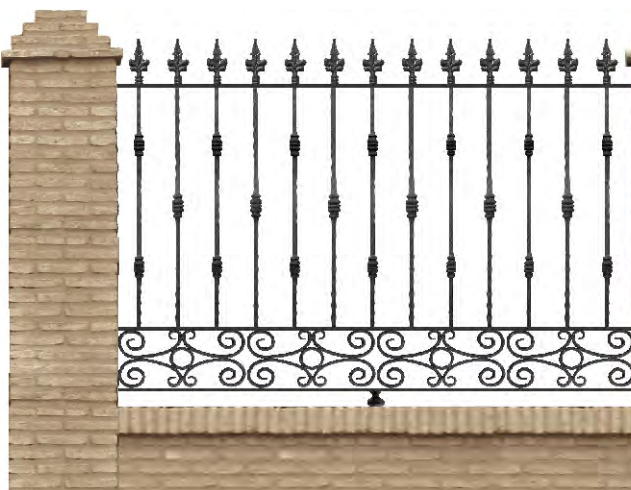

REF.:FBA024A;FBA024B;FSO007;FLA004;RE009



REF.:FBA018A;FSO010;FLA018;RE009



REF.:FBA028B;FSO011;FLA021

REF.:FPS002;FLA003;FLA028

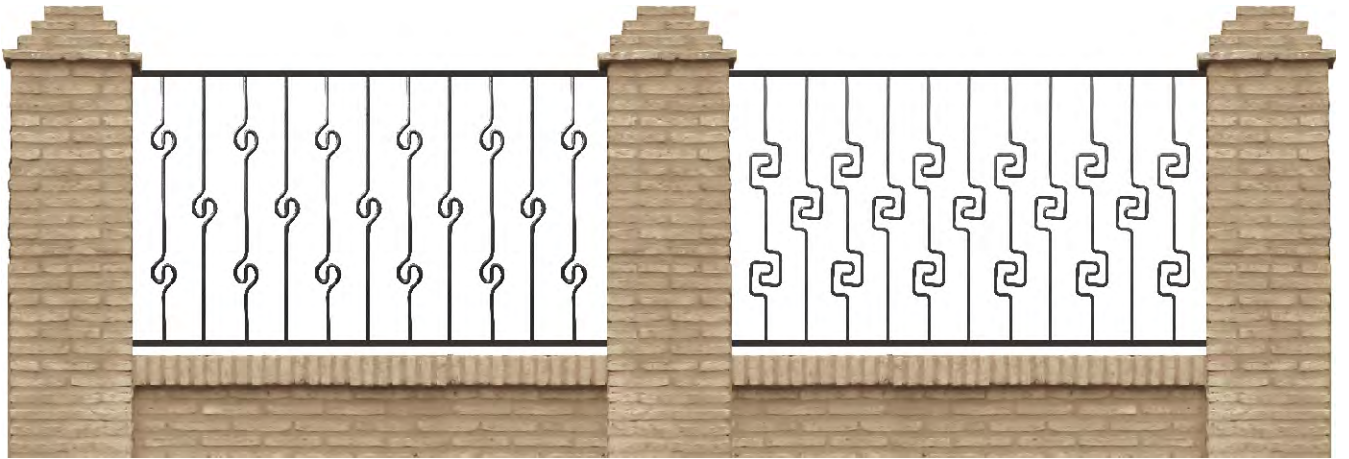

REF.:FBA055A;FBA055B

REF.:FBA056A;FBA056B



REF.:FBA002A;FBA072;FRE001;FPE007

REF.:FBA064;FBA065;FRE001



REFERENCIA
AC026;AC028
AC029;MA046
CR027



REFERENCIA
AC632;AD089
MA042;MA043
MAD043;VA688

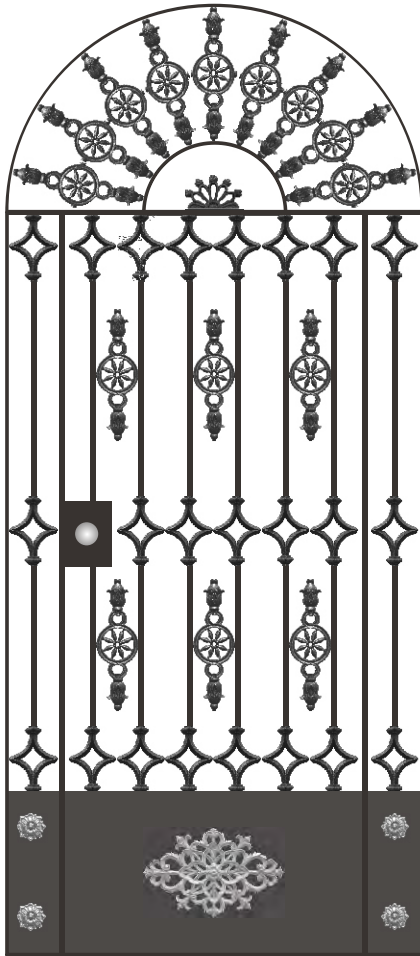

REFERENCIA
AD046;AD088
VA071;VA103
AC032

REFERENCIA
AC032;AD079
AD081;BA061
BA066

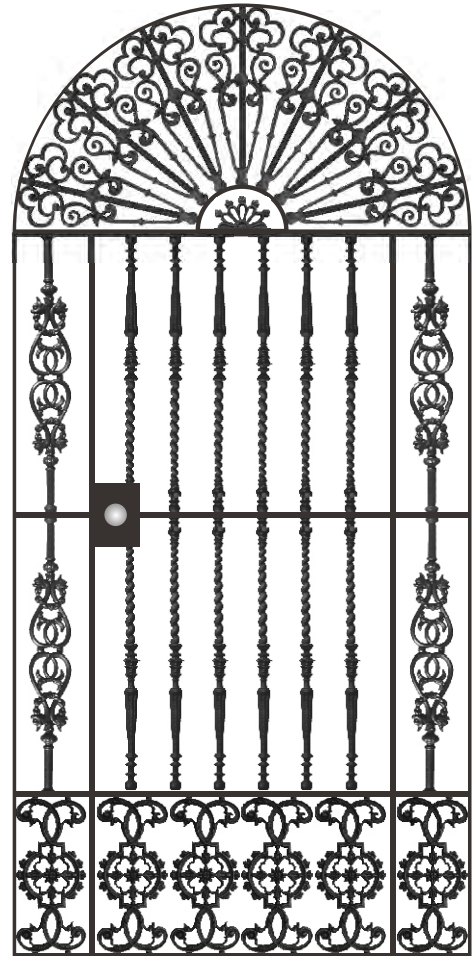

REFERENCIA
AC030;ACD031
AC034;AC035
AC036;AC113
AC114;MA035
MA036

REFERENCIA
AC024;AC025
AC050;AD041
AD043;MA029
VA071;VA088



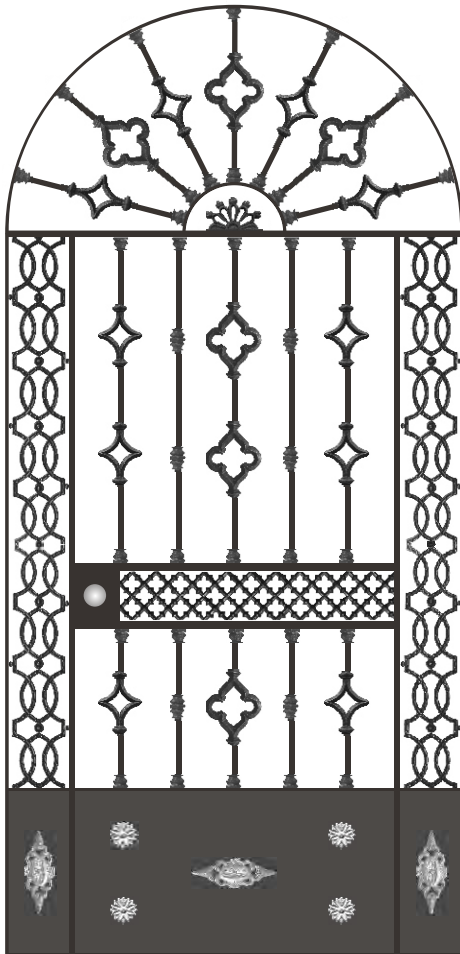

REFERENCIA
AC032;AD058
AD088;MA044
MA048;SO056
SO113;VA074
VA086

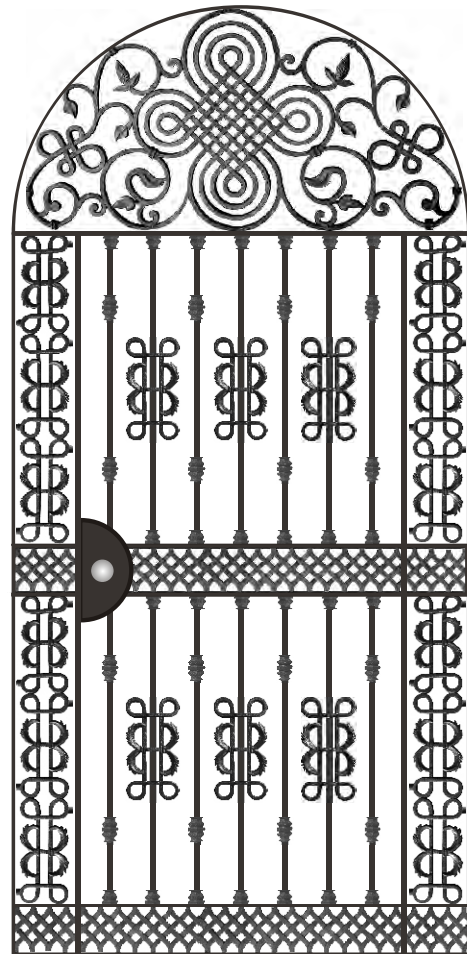

REFERENCIA
AC029;AD042
MA044;MA048
SO050;SO059

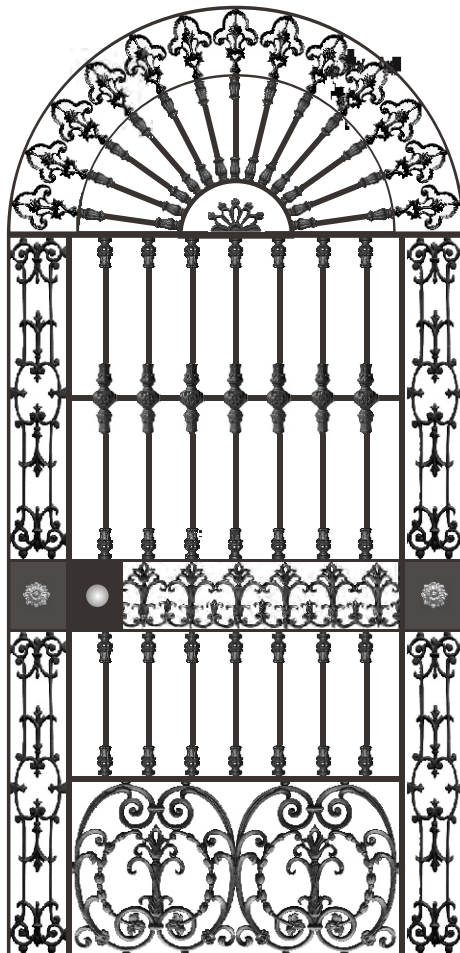

REFERENCIA
AC027;AC053
AD045;CR023
MA005;MAD043
SO054;VA071
AC032

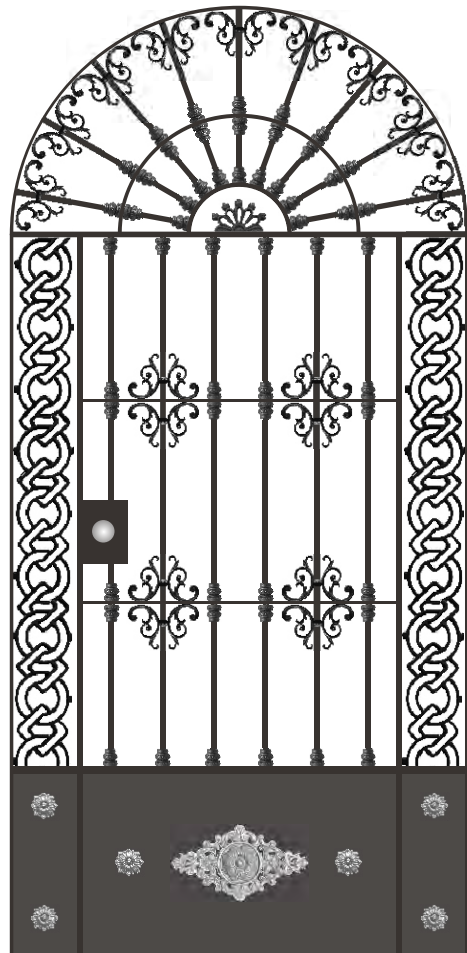

REFERENCIA
AD041;MA029
SO049;AC632
VA671;VA677



REFERENCIA
AC032;AC050
AD041;AD043
MA021;MA029
SO052

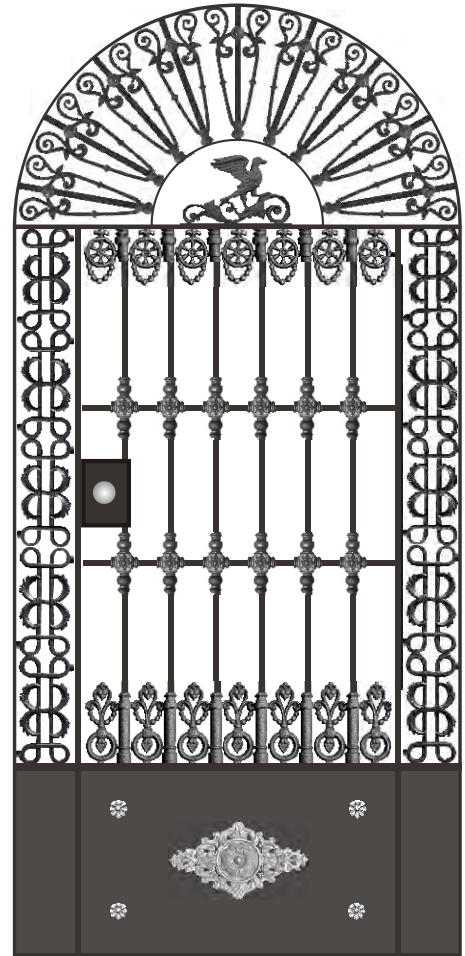

REFERENCIA
AC024;AD059
AD060;AD080
CR022;MA023
MA024;SO050
VA075;VA077

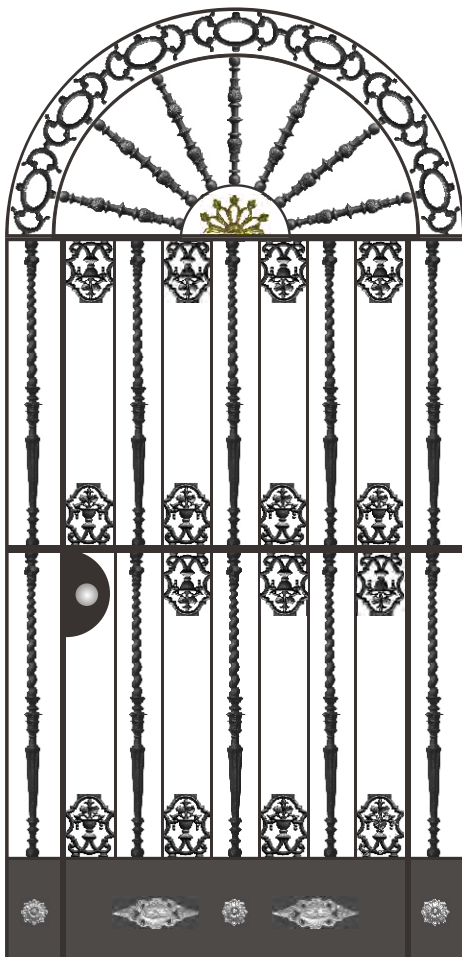

REFERENCIA
AD051;AD052
BA017;BA066
AC632;VA074
VA071

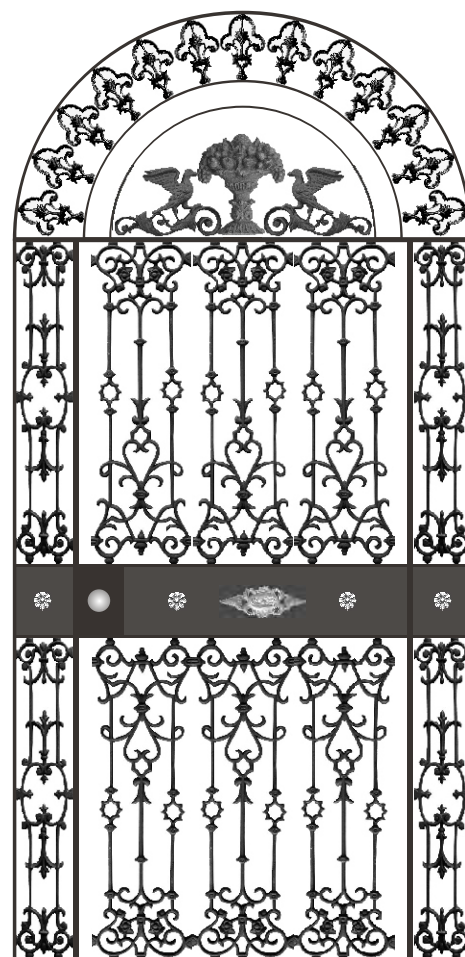

REFERENCIA
AC024;AC025
AC052;AC053
AD045;VA074
VA075

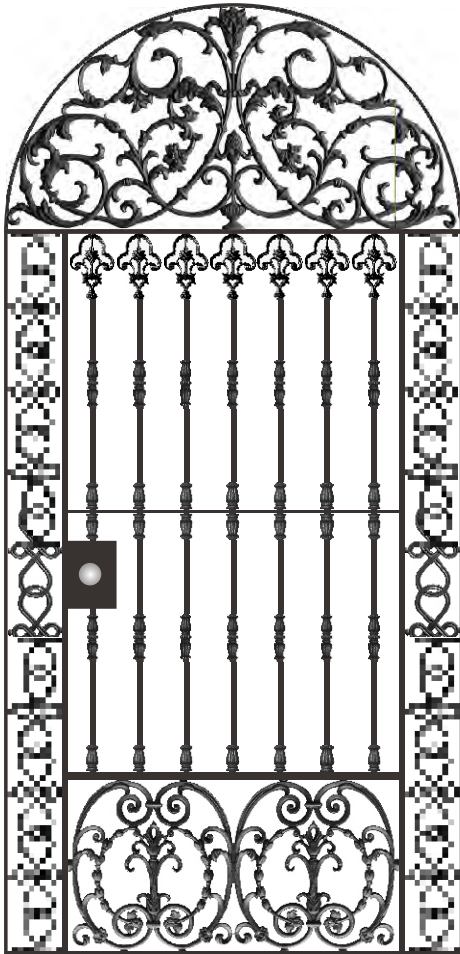

REFERENCIA
AC027;AC030
AD045;MA042
MA043;SO055

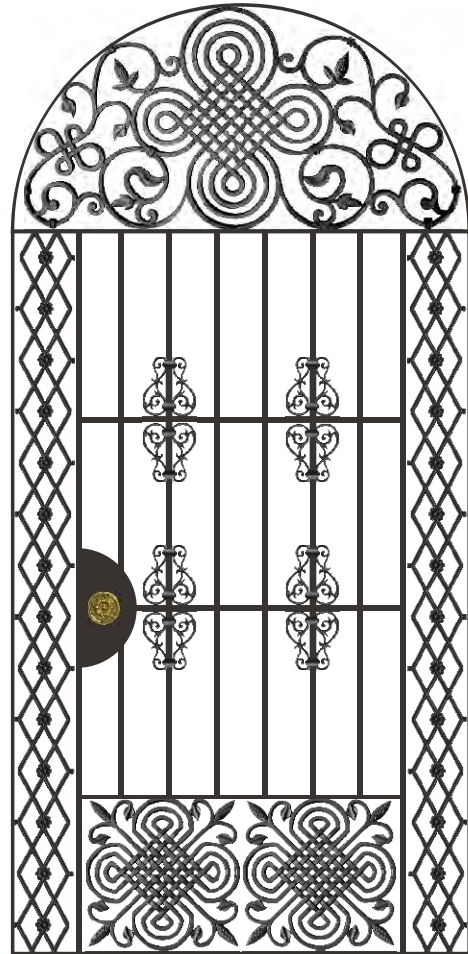

REFERENCIA
AC029;AC028
SO060;AD091



REFERENCIA
AC040;AC041
AC043;AC044
AC045;AC046
AD049;MA029

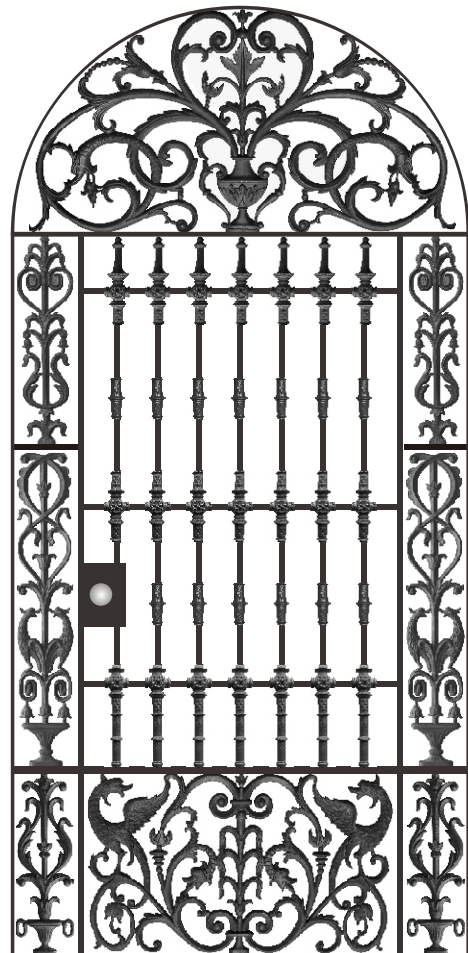

REFERENCIA
AC108;AC109
AC110;AC111
AC112;MA134
CR137;CR138
CR139

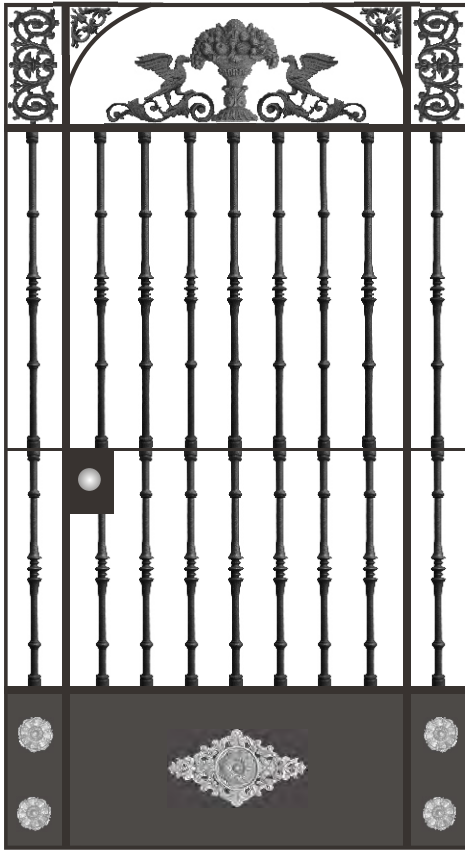

REFERENCIA
AC024;AC025
BA065;SO046
VA077;VA089
VA090

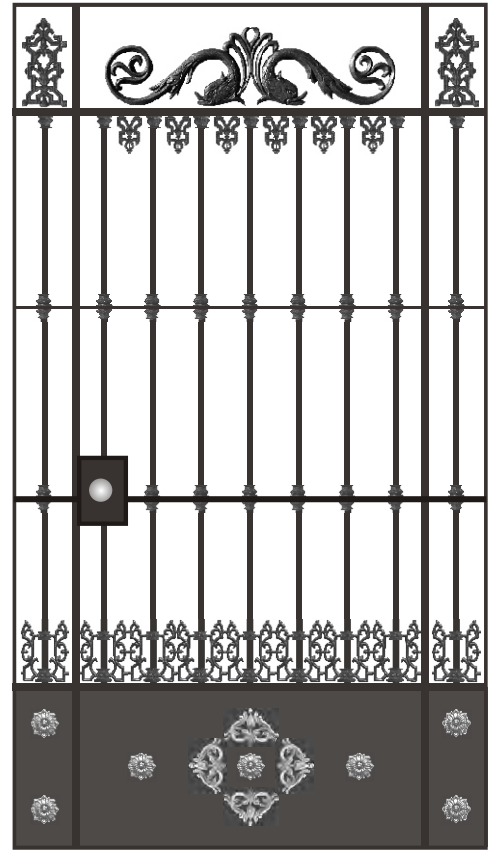

REFERENCIA
VA029;AD062
AD063;ADC087
MA044;VA071
VA089

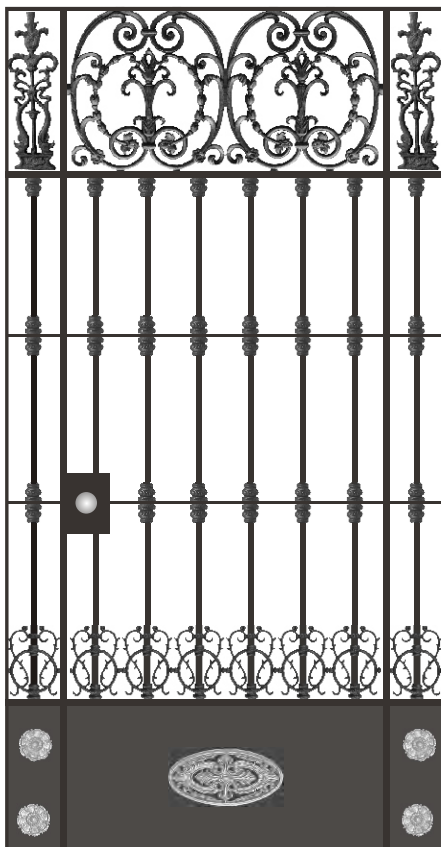

REFERENCIA
AC027;AC035
ADG067;MA029
VA088;VA090

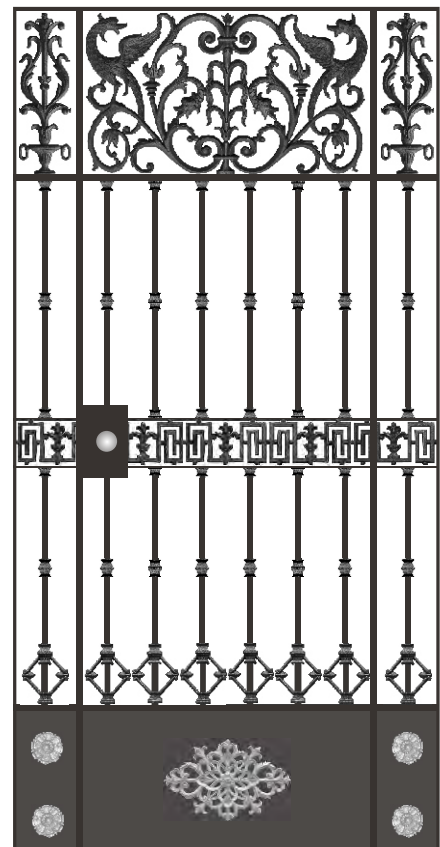

REFERENCIA
AC111;AC112
AD169;MA128
MA129;SO114
VA090;VA103

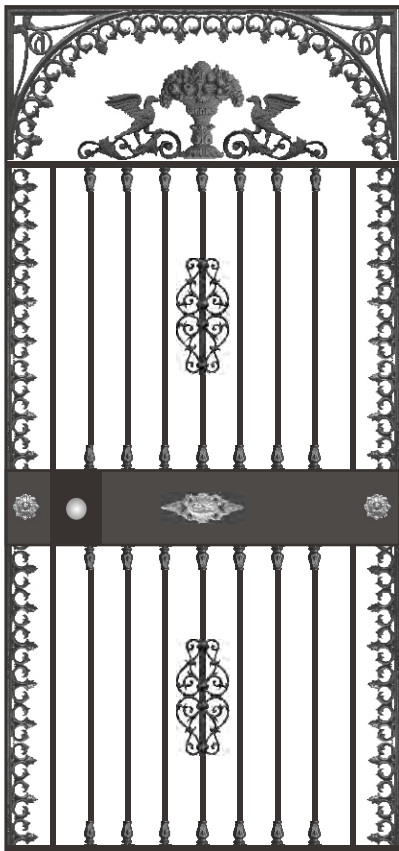

REFERENCIA
AC024;AC025
AD084;AD085
MA017;AD090
VA071;VA074

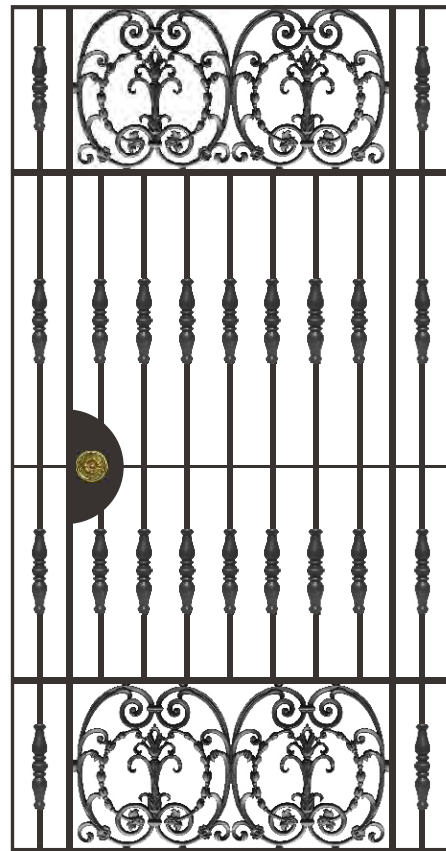

REFERENCIA
AC027;MA028

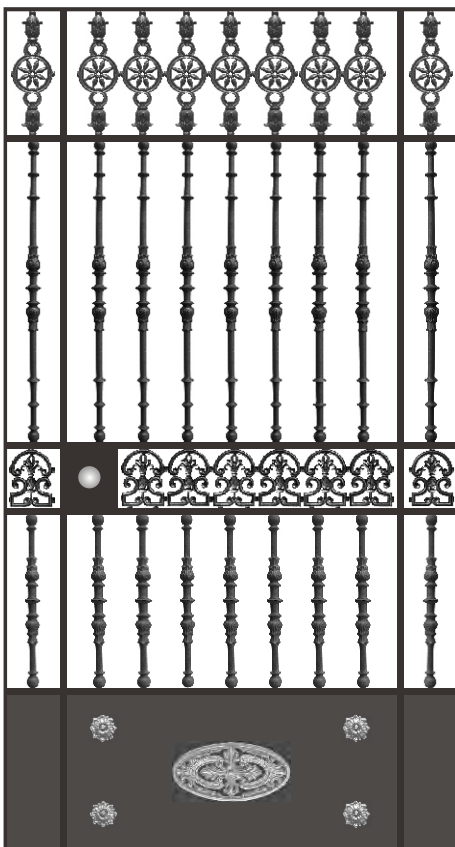

REFERENCIA
AD046;BA017
SO058;VA071
VA088

REFERENCIA
AC028;SO113
MA035;MA036
VA077;VA086

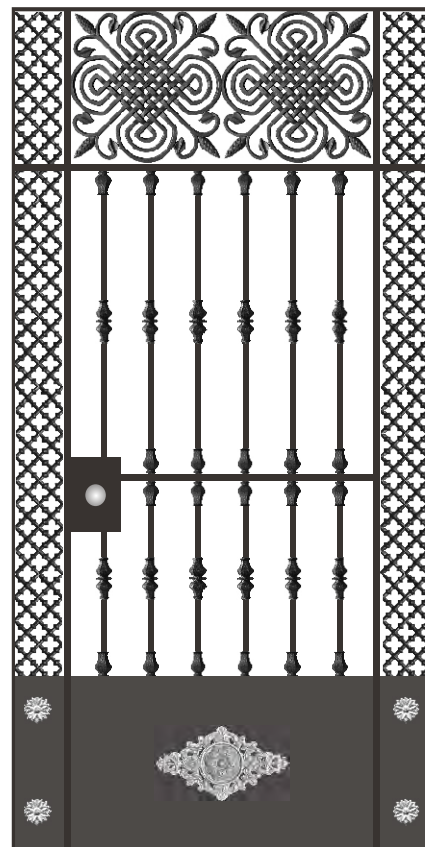

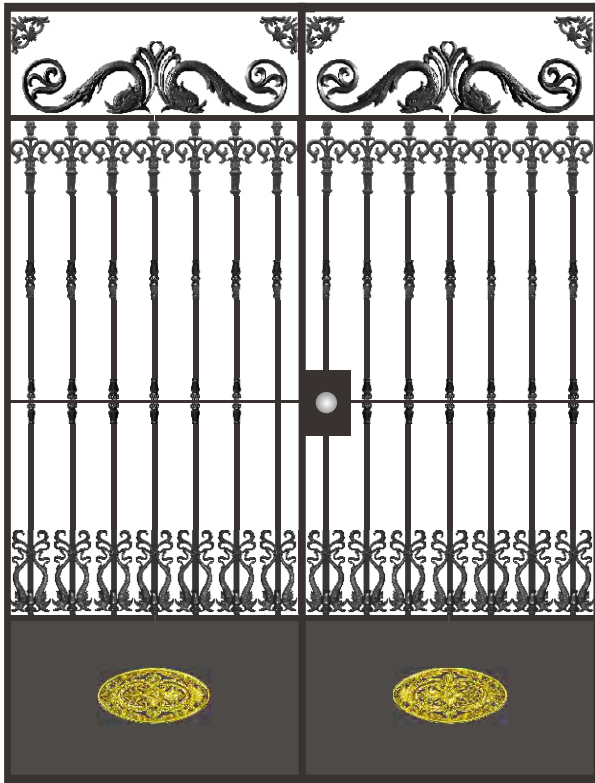

REF.:VA029;AD048;AD050;MA030;MA031;VA089;VA688

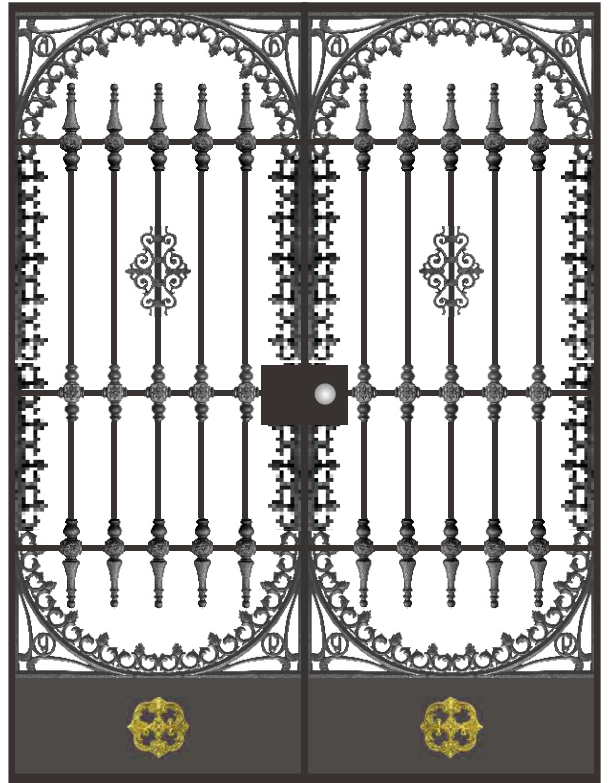

REF.:AD065;AD084;AD085;CR022;CR025;VA673



REF.:AC025;AD084;AD085;MAG010;CR023;AD068;VA677

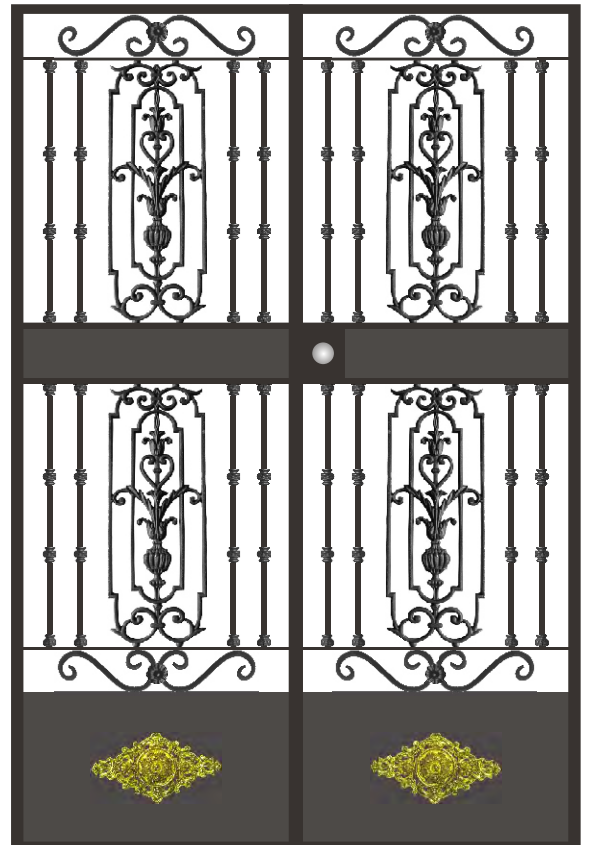

REF.:AC054;MA049;MA050;FS001;FVA003;VA677

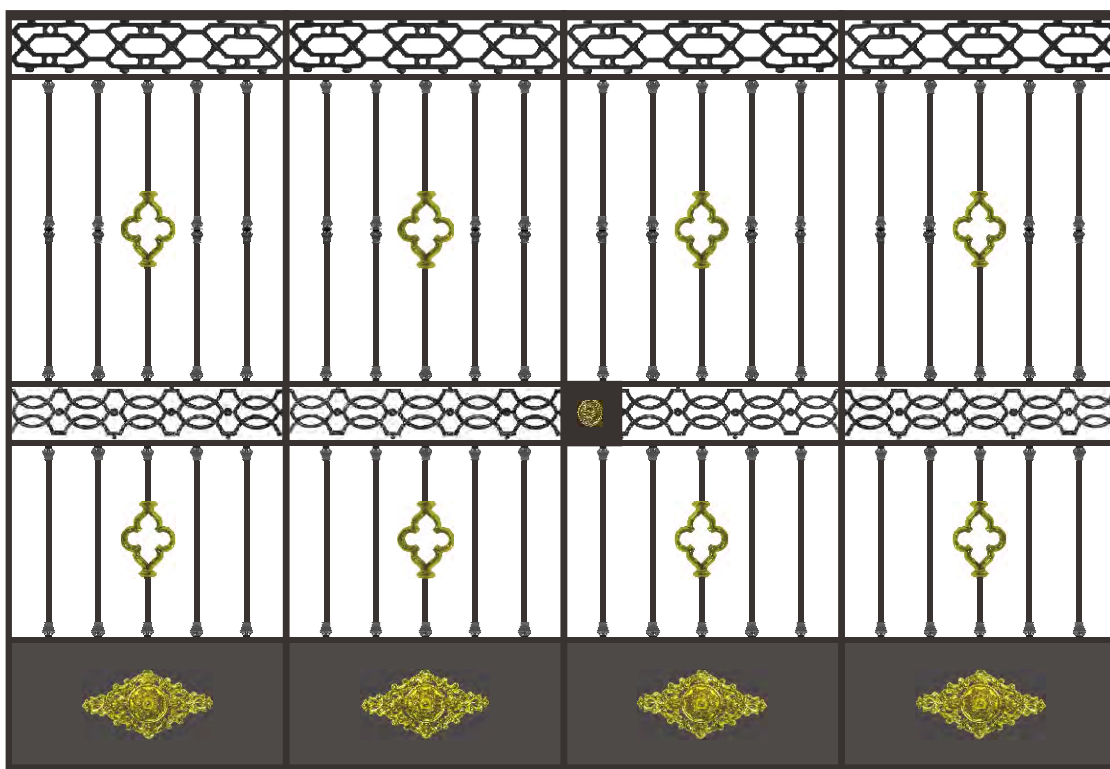

REF.:MA046;MA047;SO044;SO056;AD658;VA677

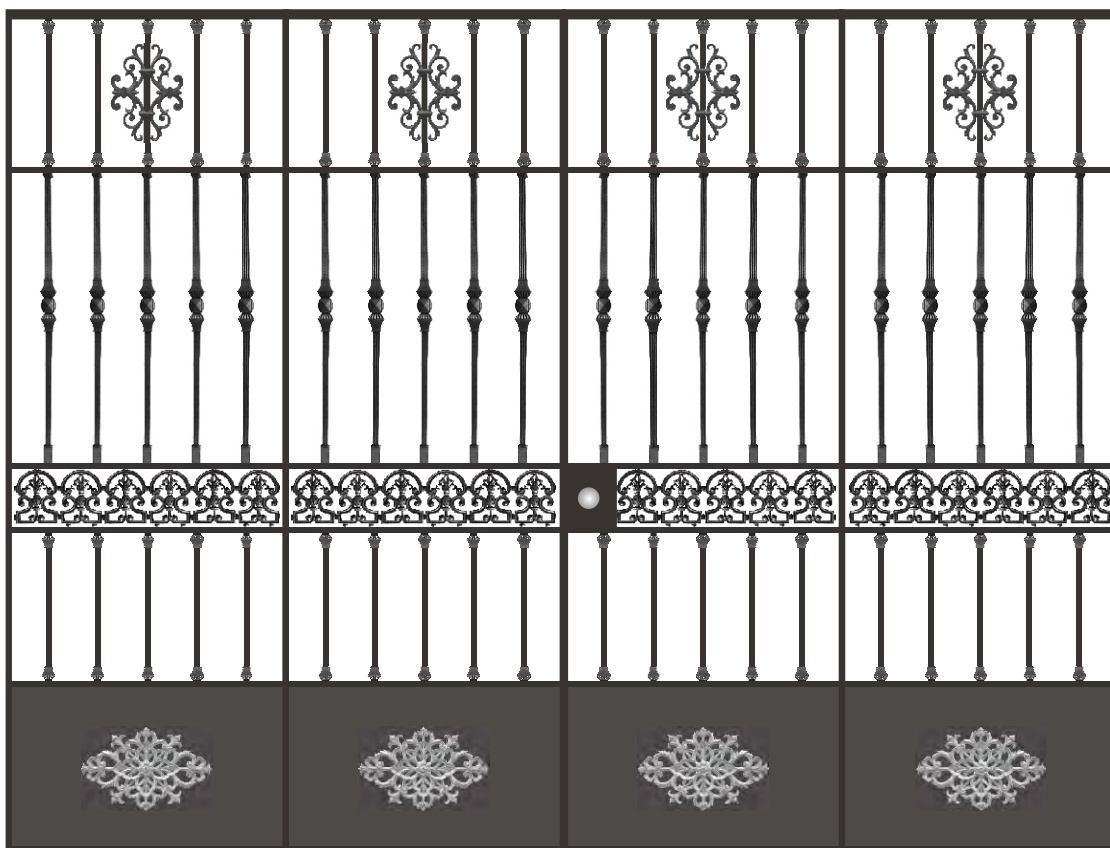

REF.:ADC043;BA029;MA046;SO058;VA103

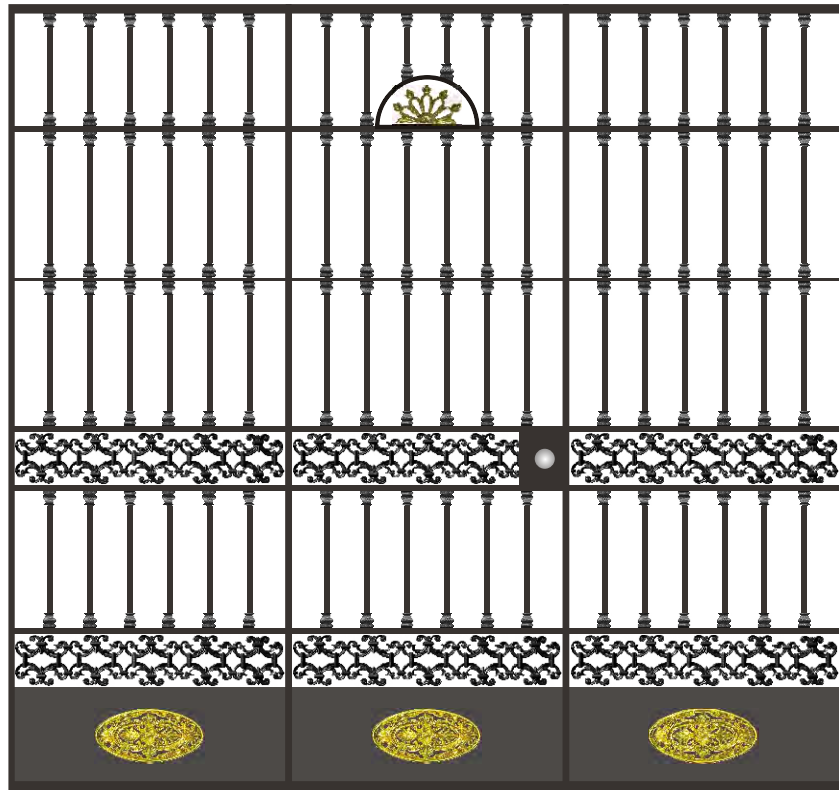

REF.:MA044;MAD048;SO053;AC632;VA688

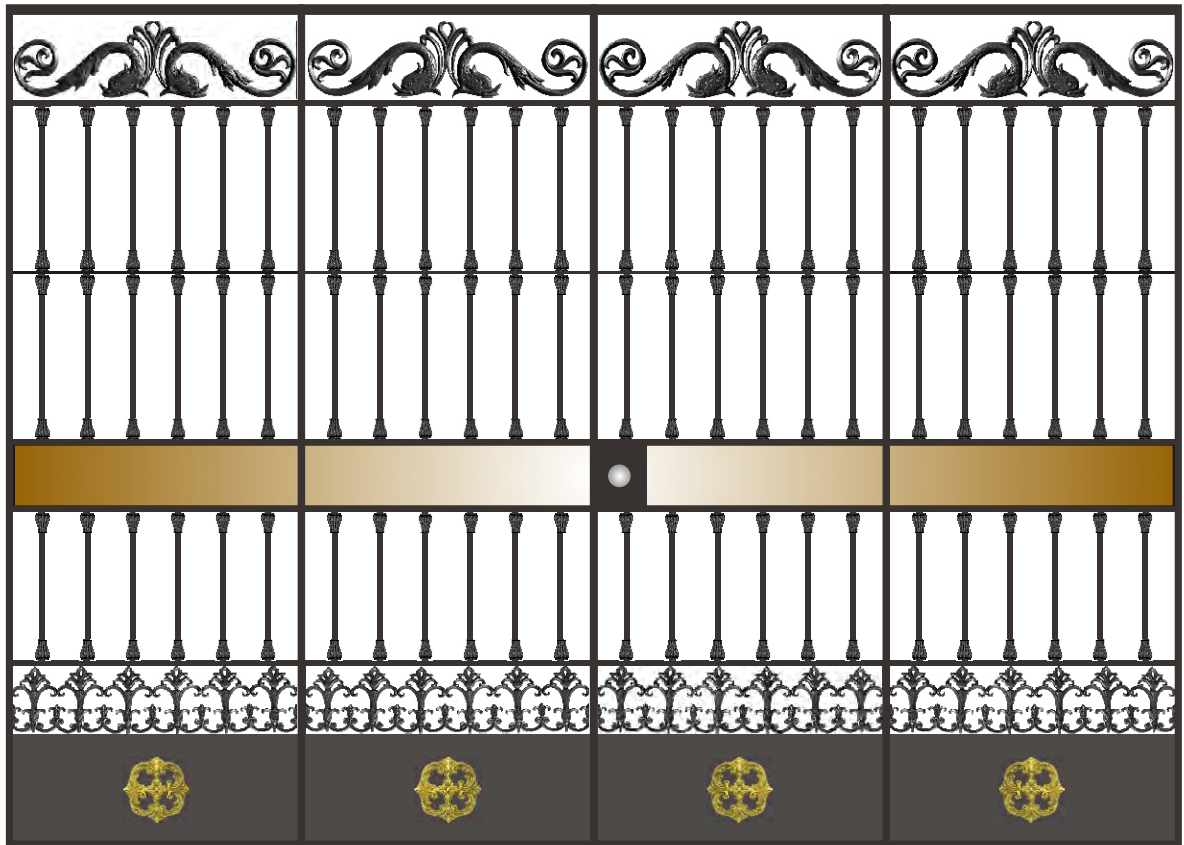

REF.:MA011;SO054;VA029;VA673



REF.:MA048;MA044;MAD048;AD052;AD071;VA077;VA075

REF.:DF5034S REF.:BA062;BA066;SO052;VA088



REF.:AD090;SO058;LA013;VA074;VA089

REF.:MA029;AD045;AD046;VA088

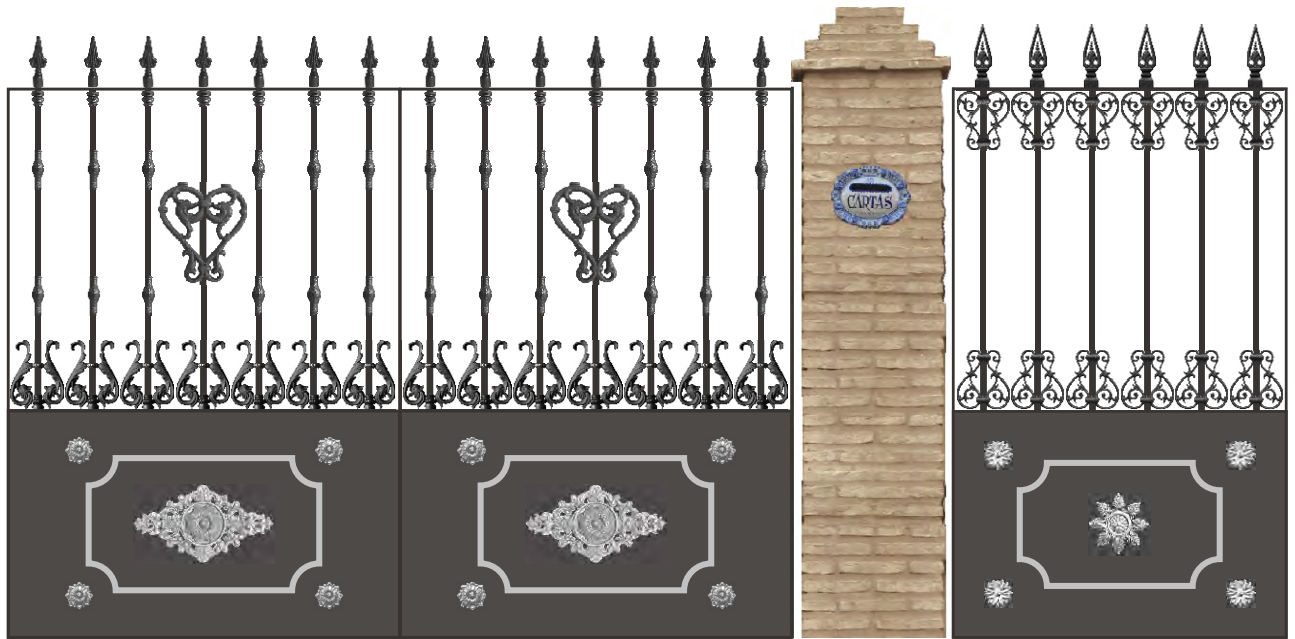

REF.:MA029;MA040;AD049;AD054;LA026;VA077;VA071

REF.:AD091;LAC013;VA070;VA086

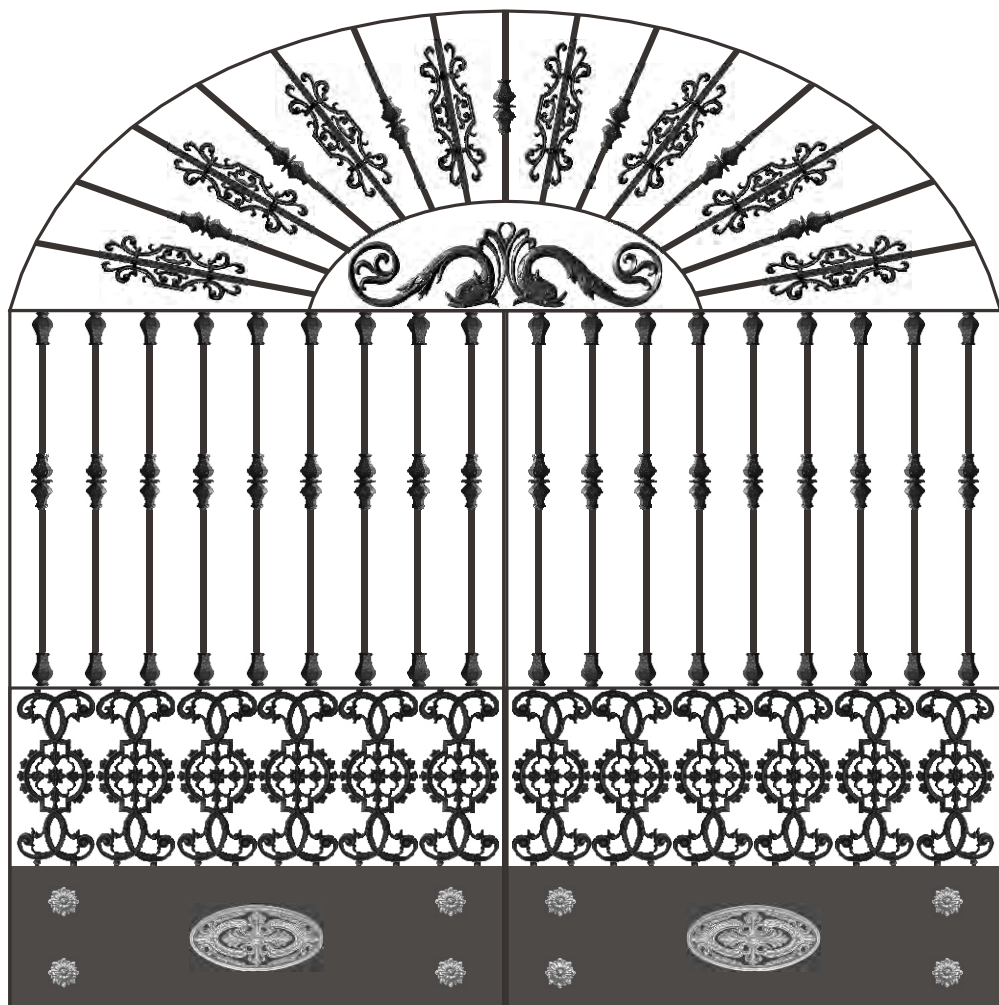

REF.:MA035;MA036;AD070;AD081;VA029;VA088;VA071

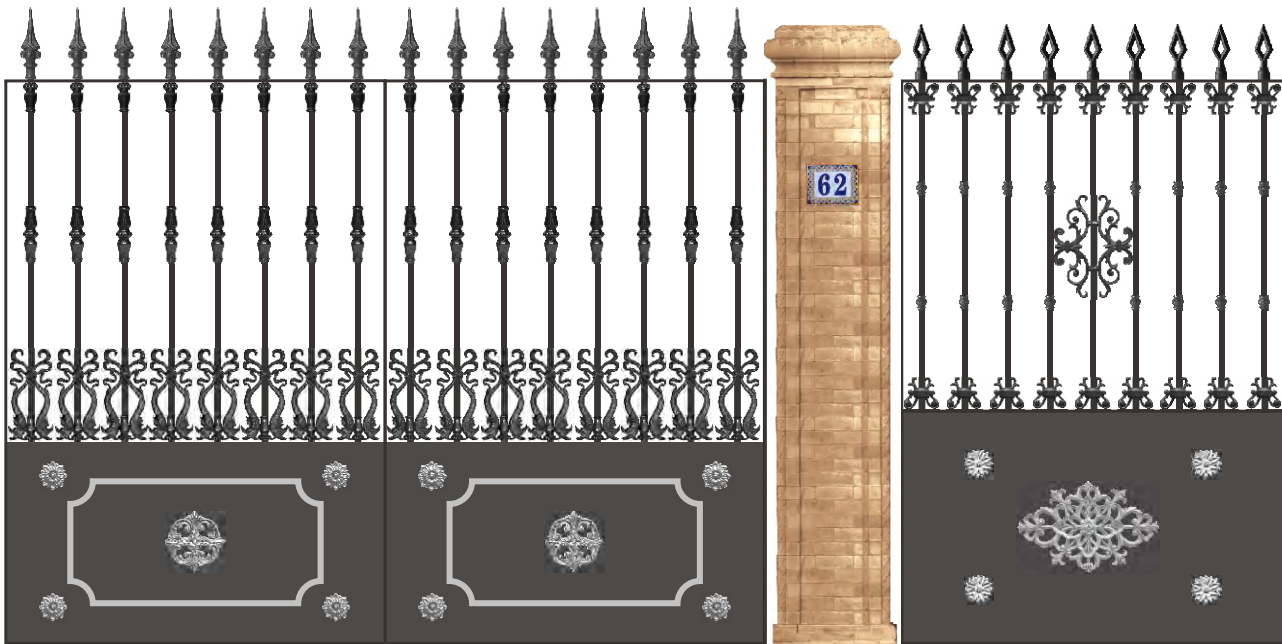

REF.:MA030;MA031;AD048;LA024;VA073;VA071

REF.:MA008;MA021;LA014;AD043;VA103;VA086

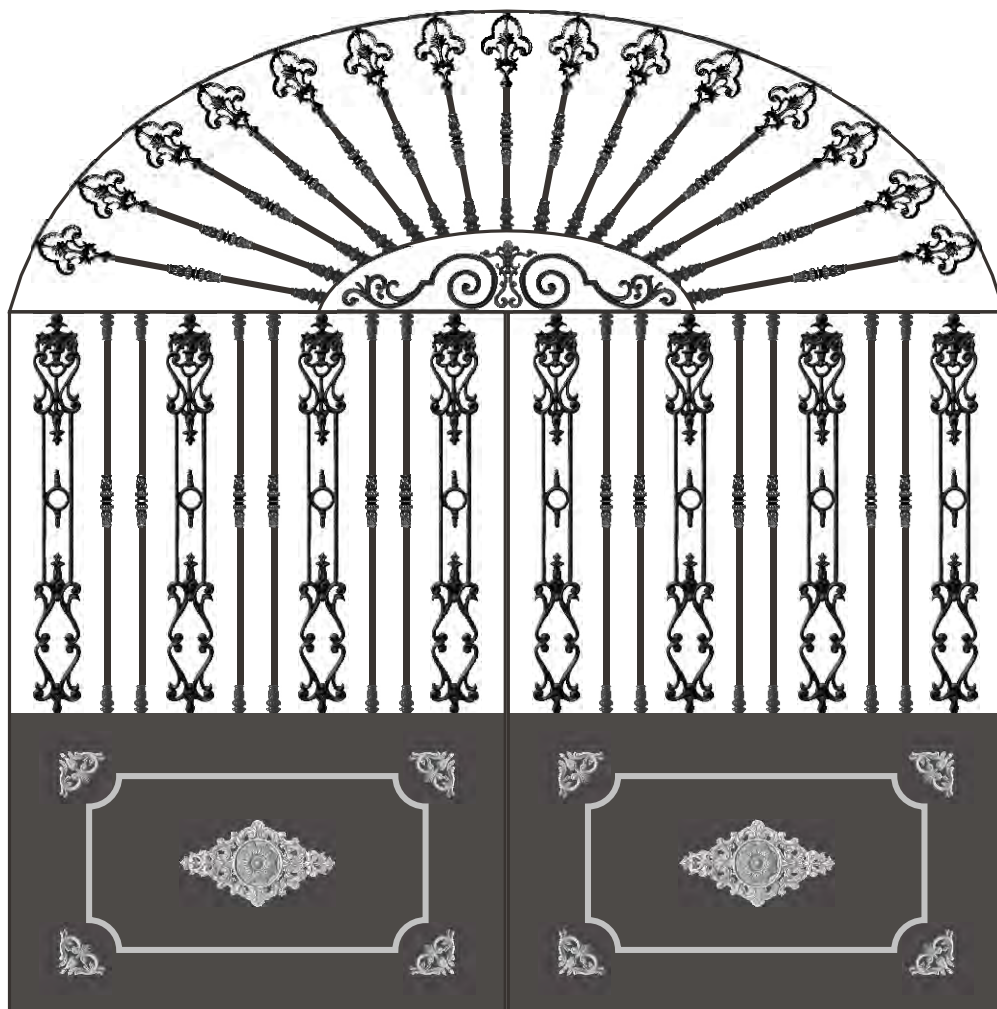

REF.:AC050;AD045;MAP010;MAD010;MAP020;VA077;VA089;VA104;VA105

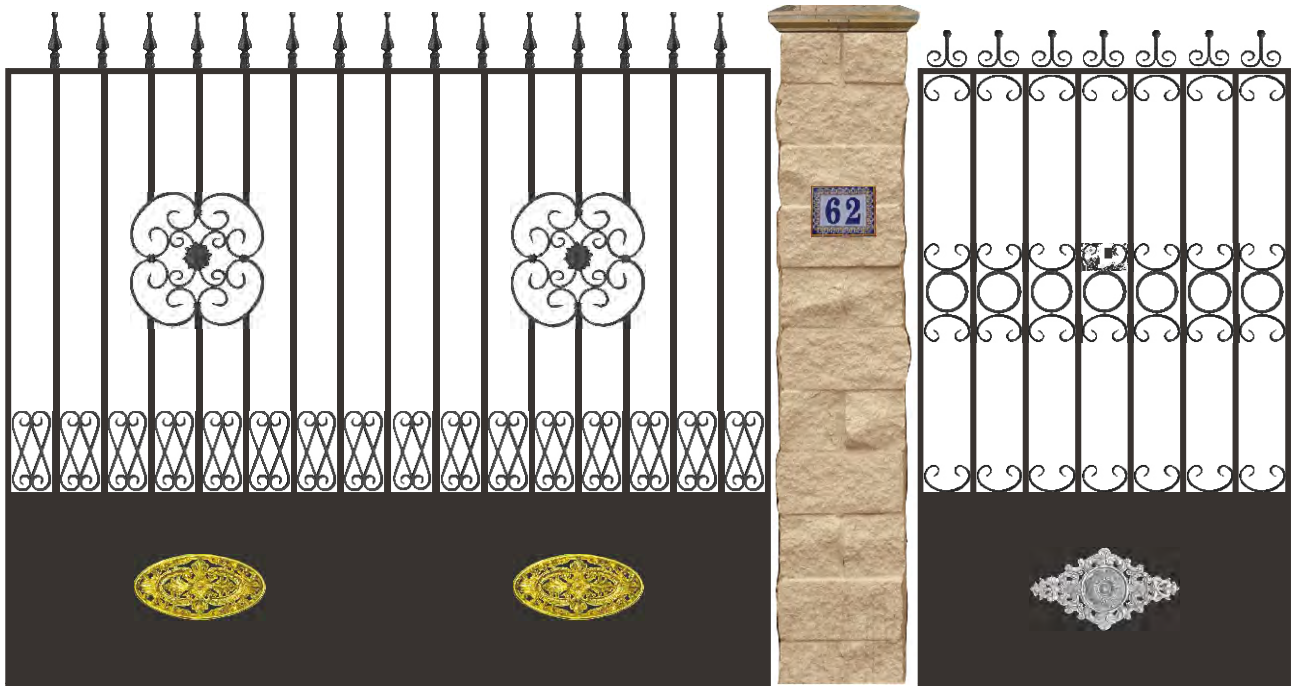

REF.:FAD015;FAD024;FLA007;VA688

REF.:FC003;FLA020;FVA026;VA077

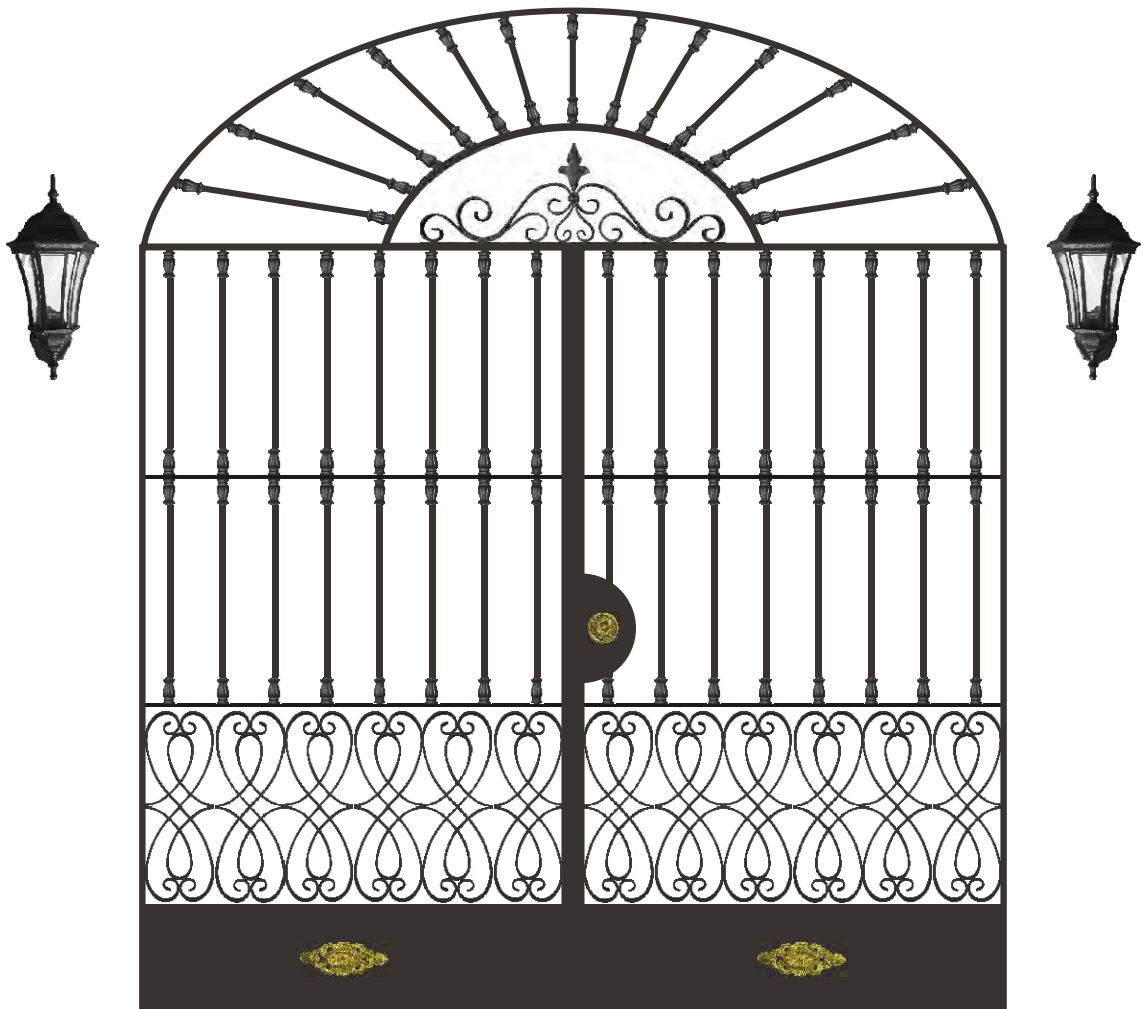

REF.:FAD016;FPE003;MA042;MAD043;VA674



REF.:FBA037;FBA038;FLA003;FME001;VA677

REF.:FBA004A;FBA019A;FAC007;FLA003

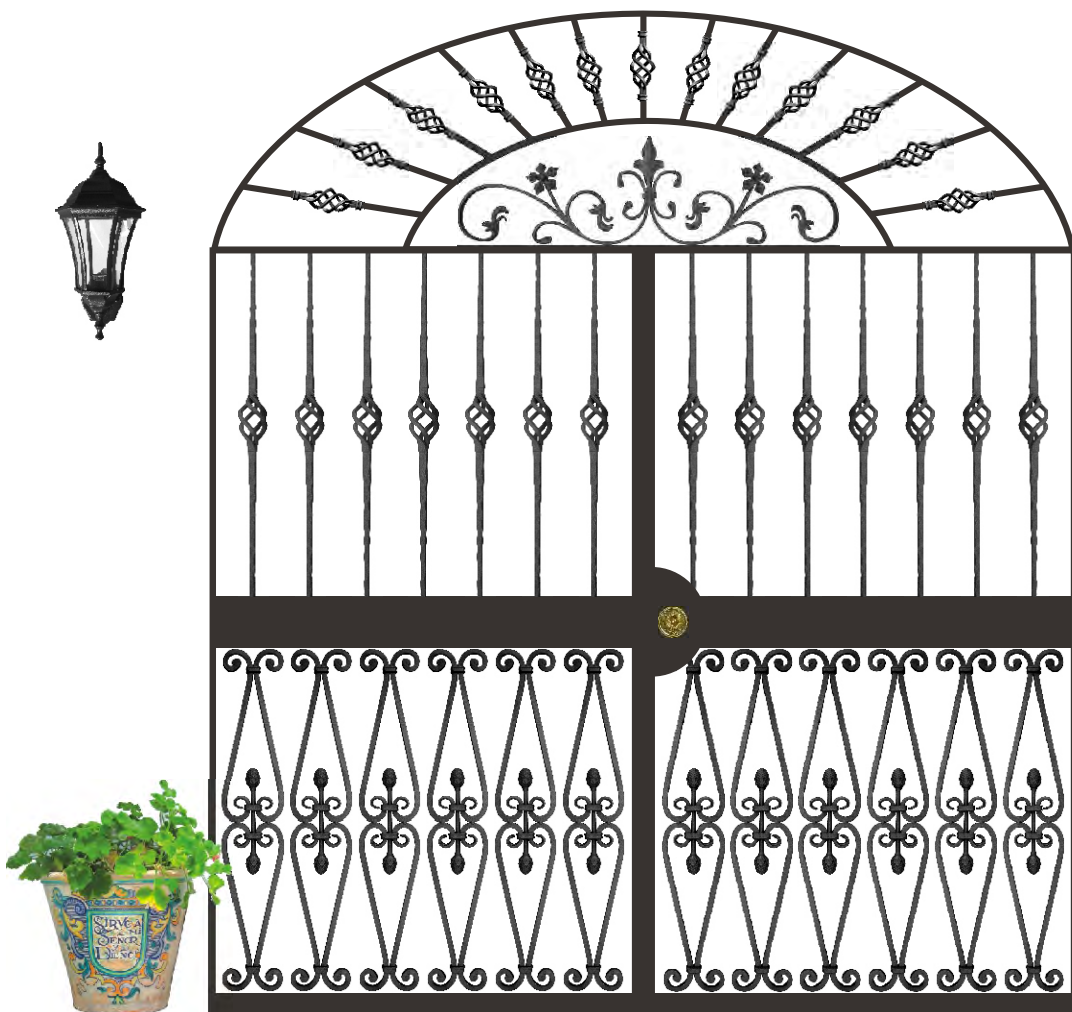

REF.:FBA019A;FBA043;FPE001;FVA006

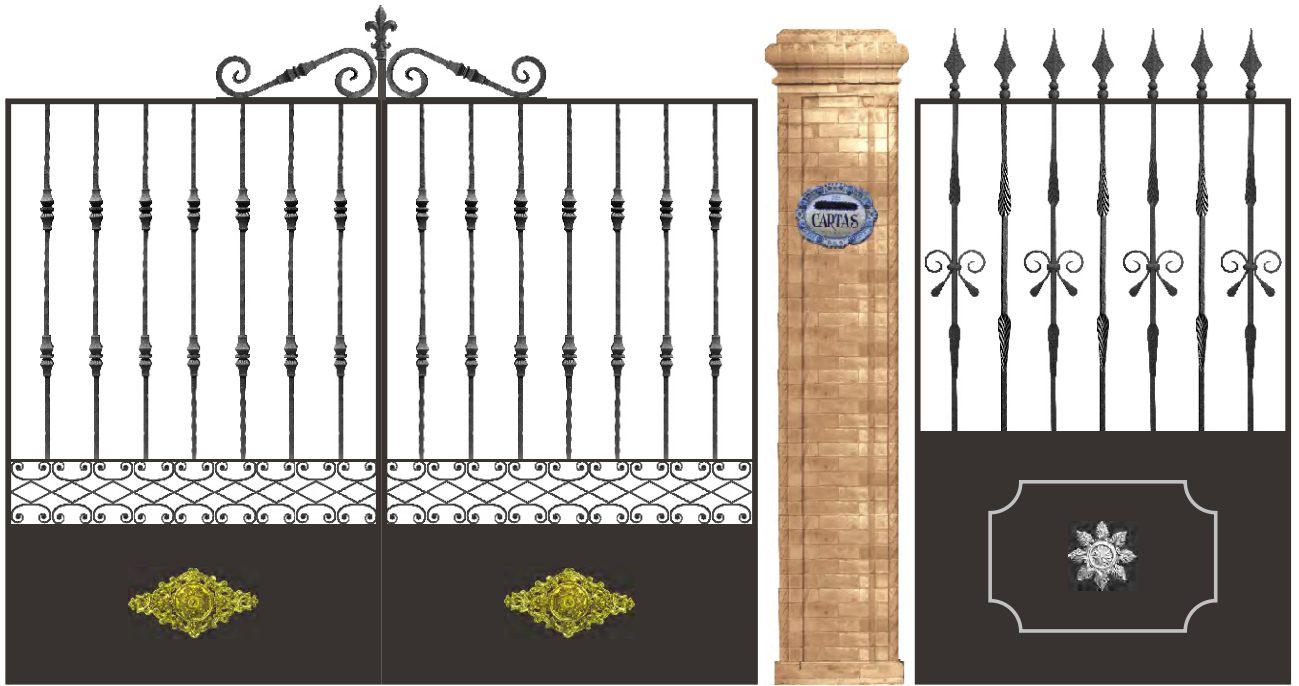

REF.:FBA023B;FSO003;FLA010;FME023;VA677

REF.:FBA002B;FBA033;FLA018;VA070

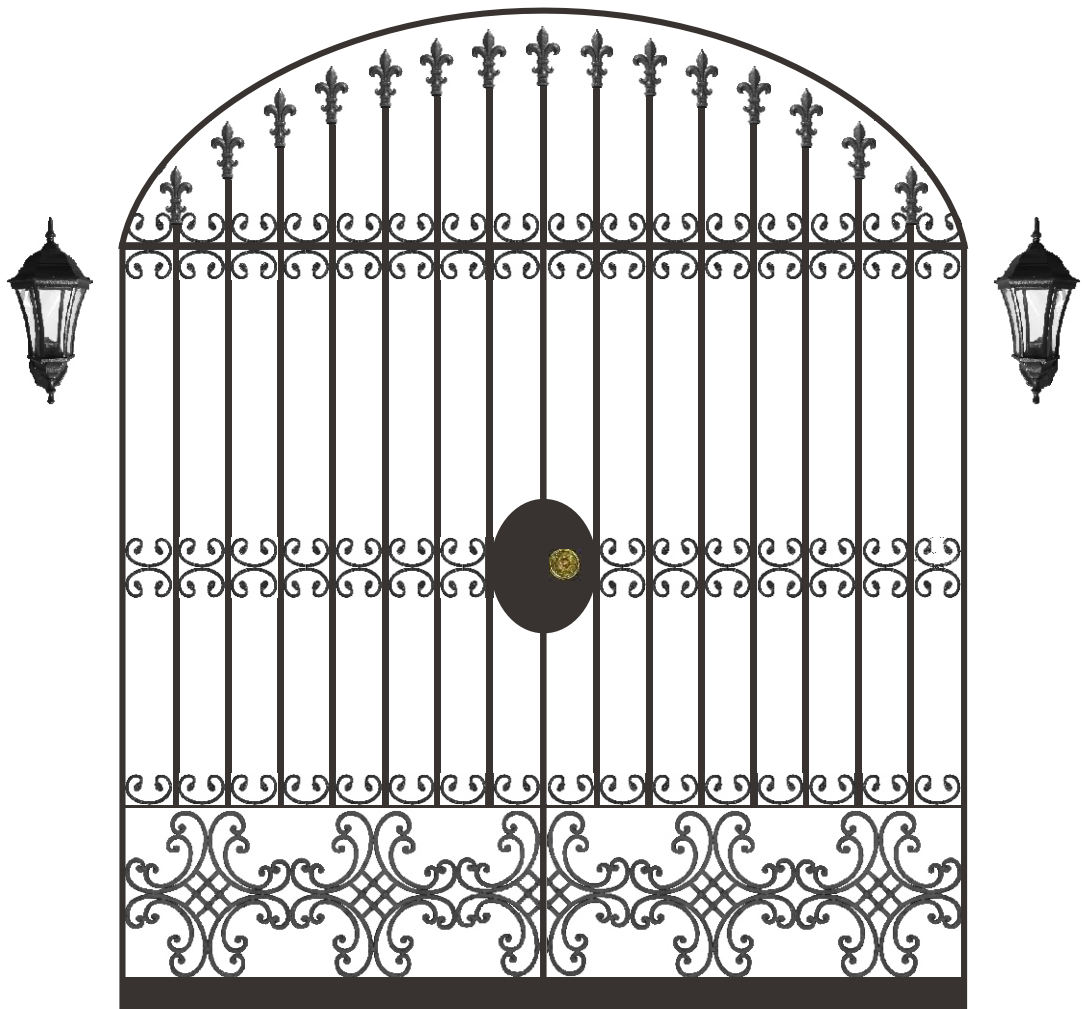

REF.:FAD025;FC002;FLA010

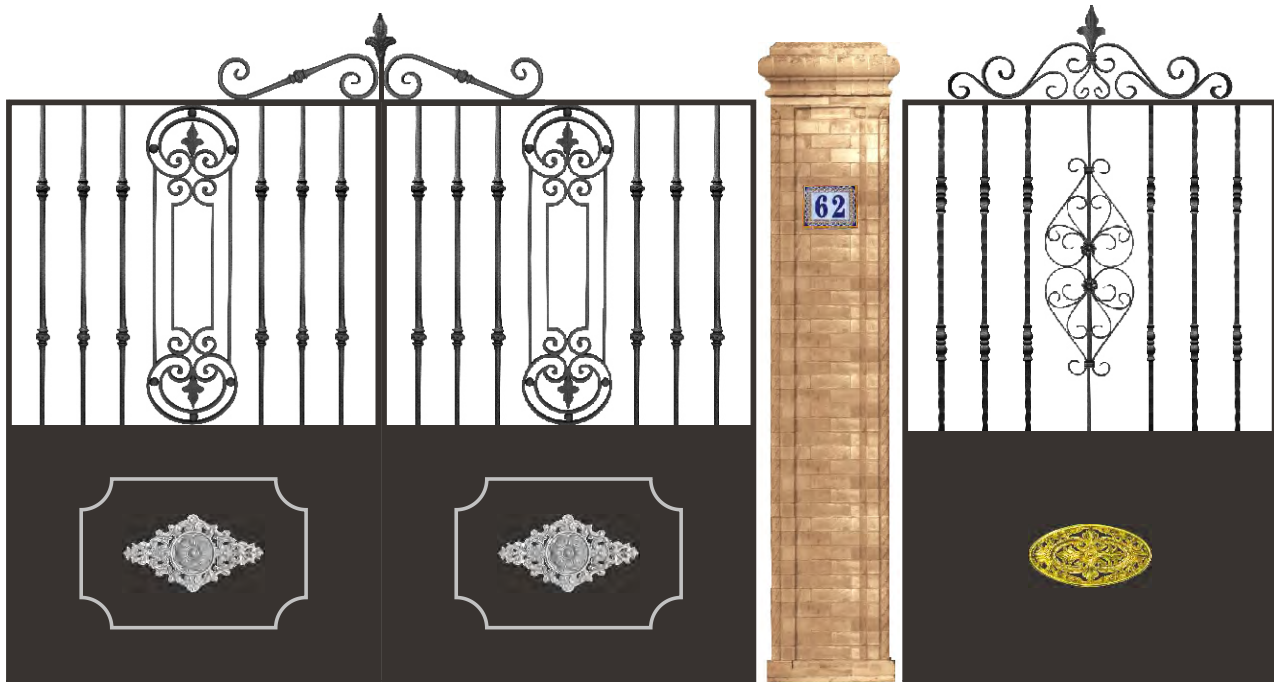

REF.:FBA025B;FBA044;FLA021;FME025;VA077

REF.:FBA035;FBA012B;FPE003;VA688



REF.:FAC008;FAD004;FAD015;FPE002;FS006



REF.:FAD014;FSO009;VA677;MA044;MA048

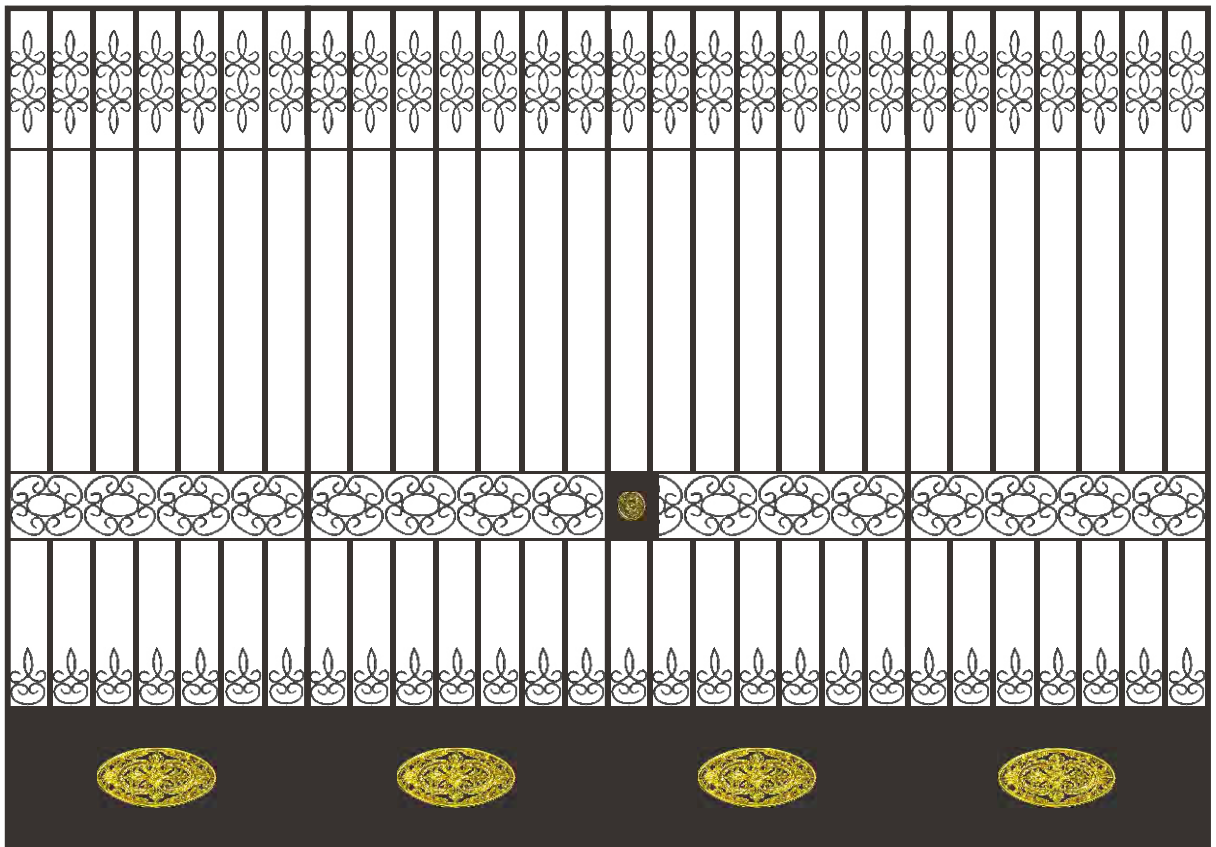

REF.:FAD003;FAD005;FSO004;VA688



REF.:FBA050;FAD015;FC004;VA673

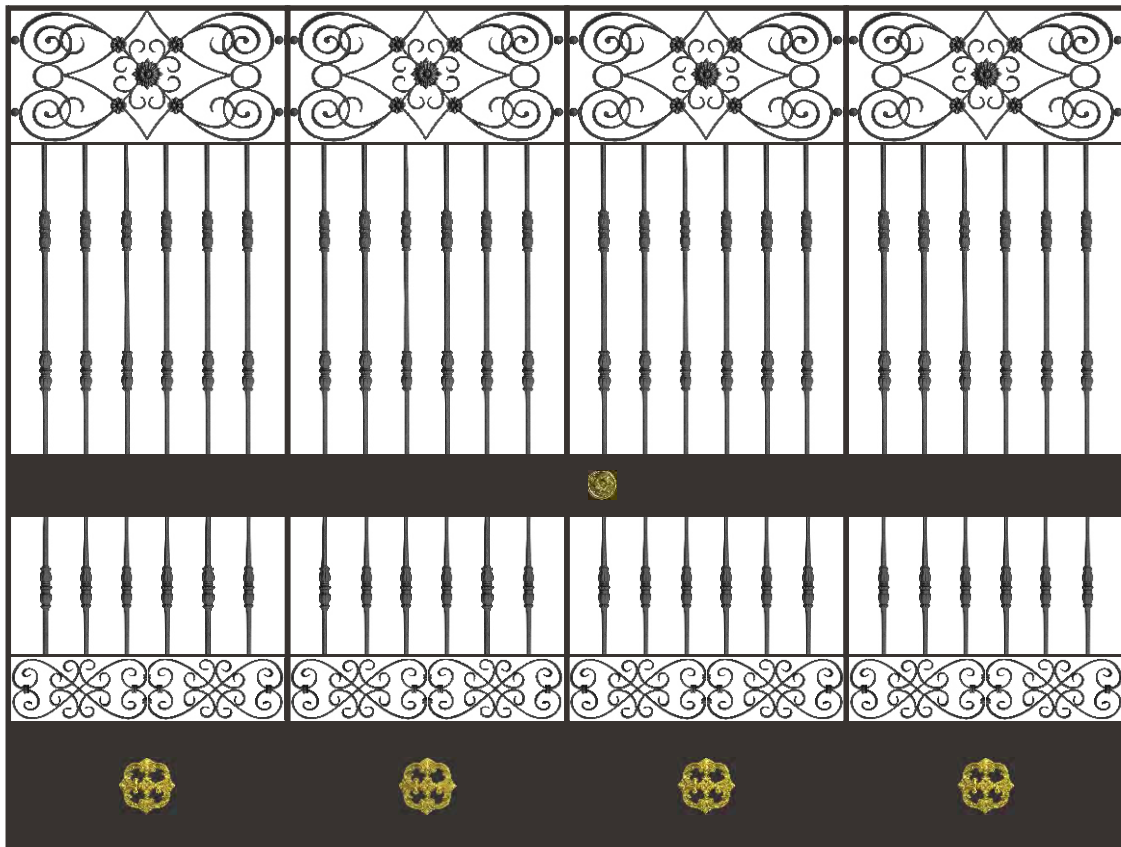

REF.:FRE001;FBA022A;FBA022B;FAC006;FSO001;VA673



REF.:FAD007;FSO010;VA674

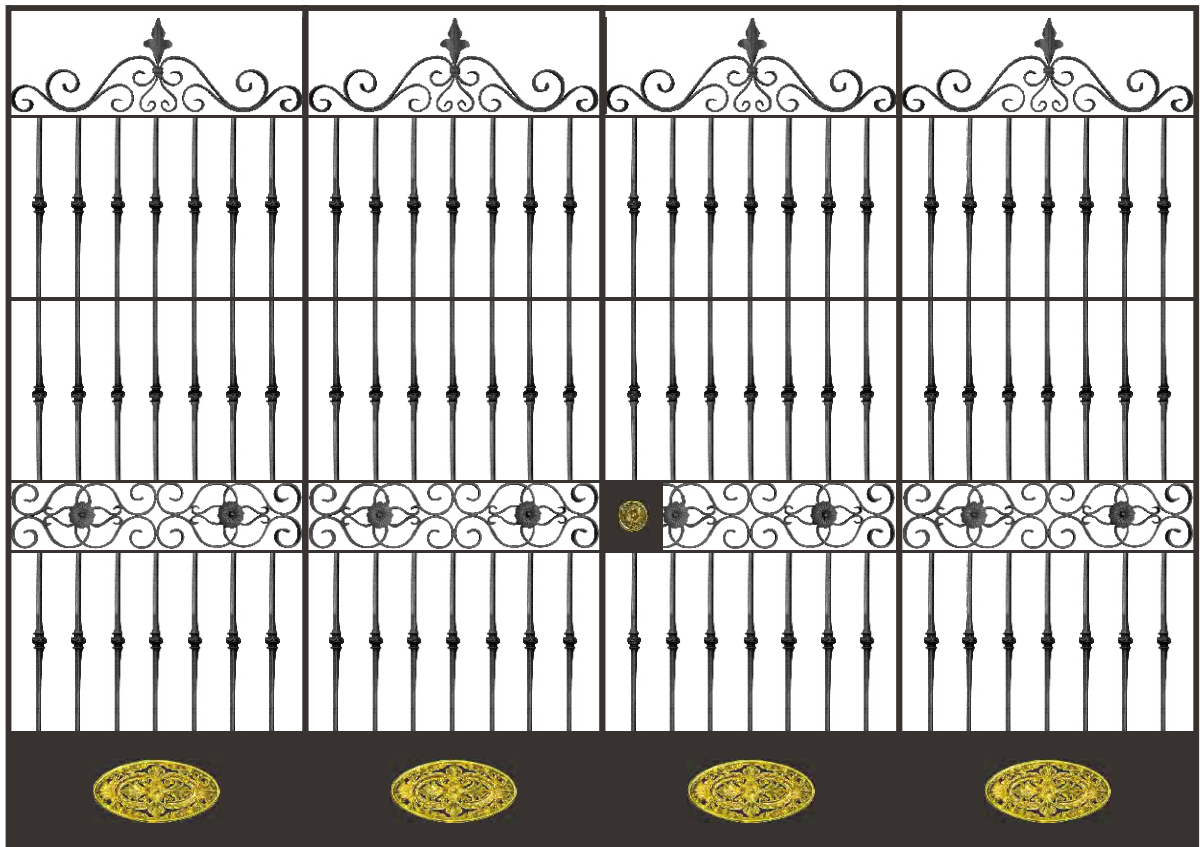

REF.:FBA025A;FSO002;FPE003;VA688

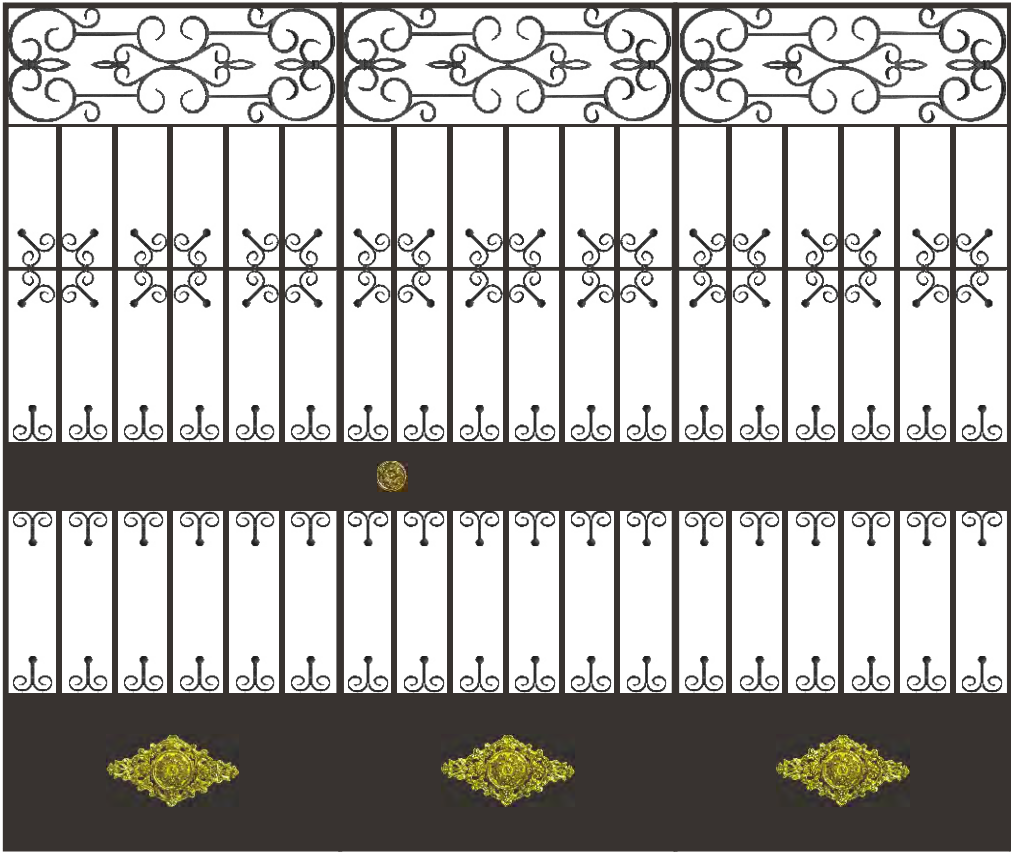

REF.:FBA042;FLA020;VA677

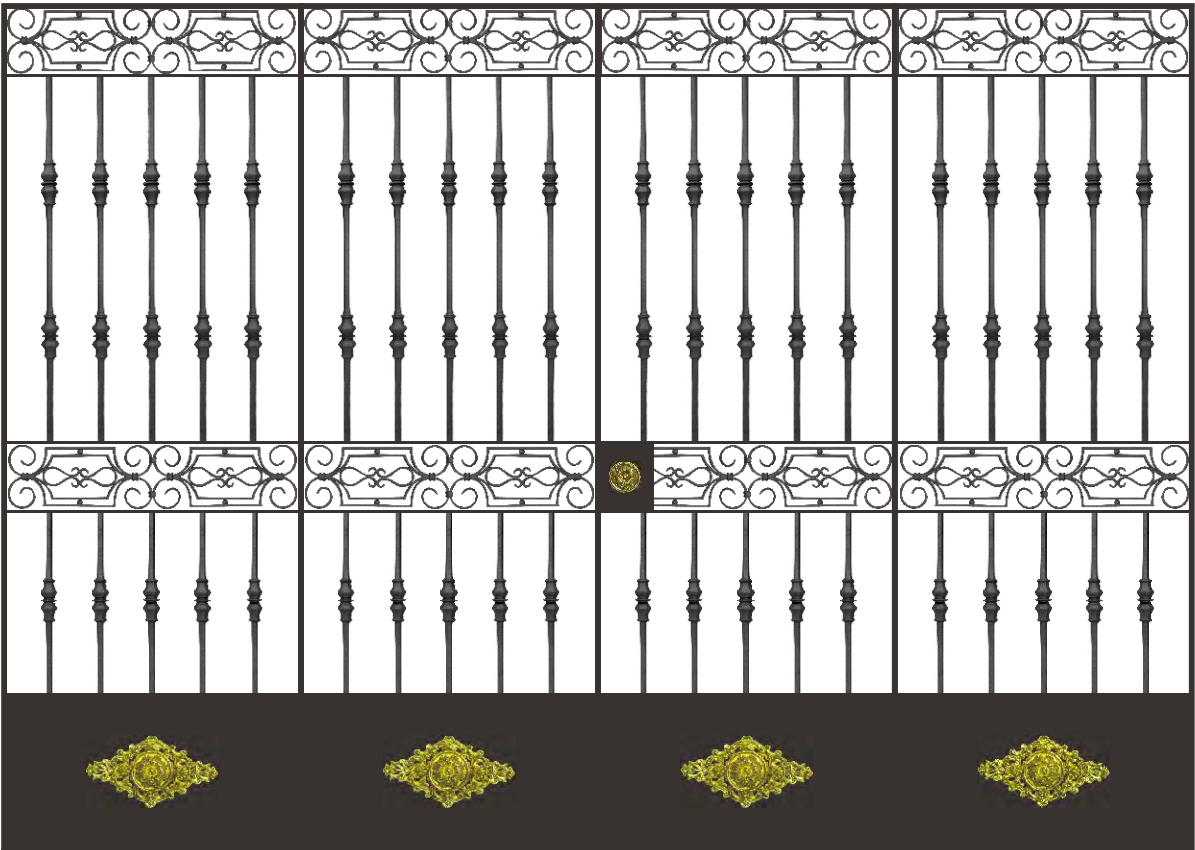

REF.:FBA021A;FBA021B;FSO008;VA677

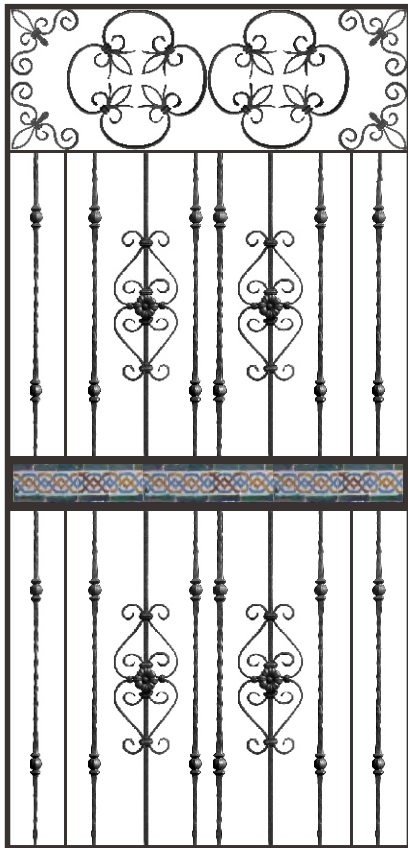

REF.:FBA003B;FBA030;FAC010;FAD023

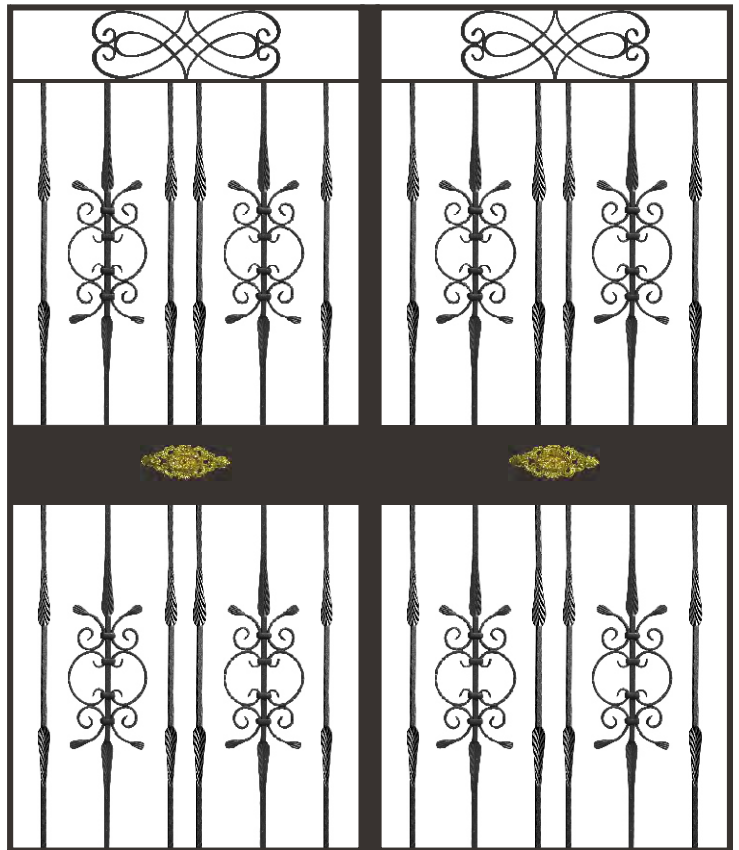

REF.:FBA002B;FBA031;FAD016;VA674

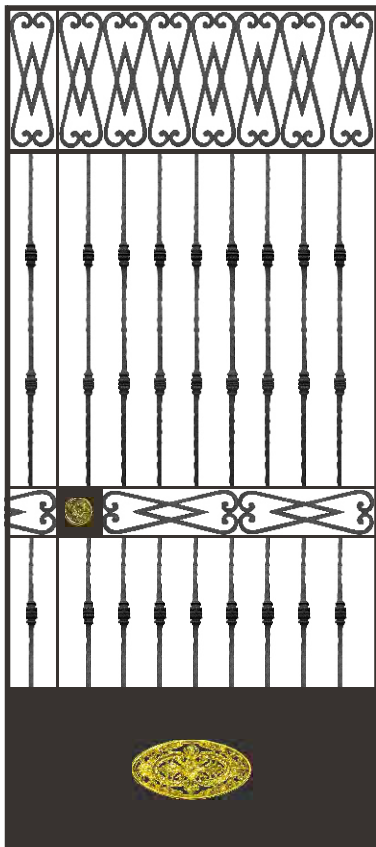

REF.:FBA024A;FBA024B;FAD017;VA688

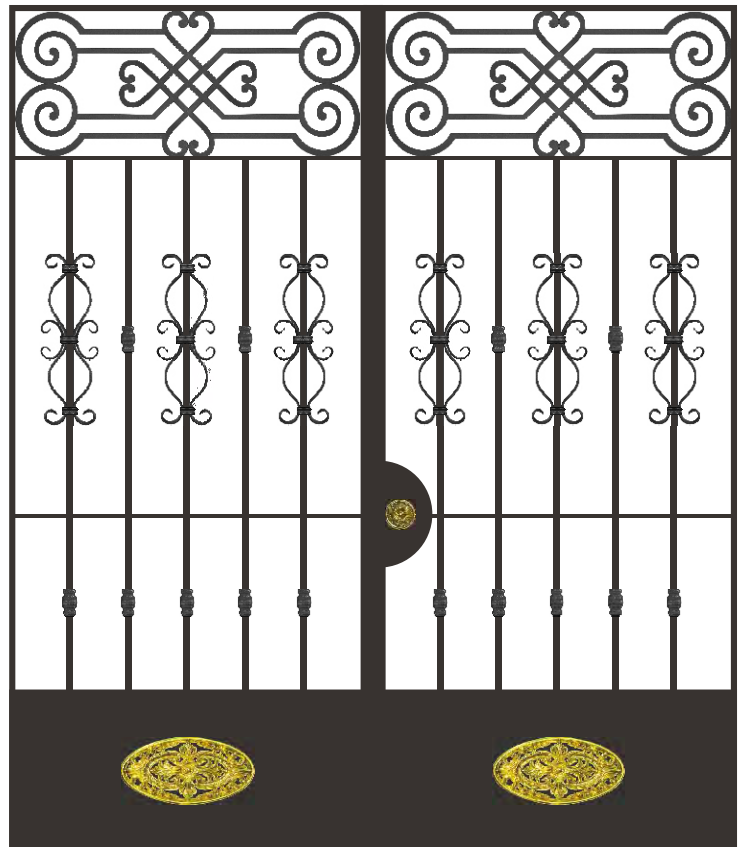

REF.:FBA040;FC003;FE003;FMA055;VA688

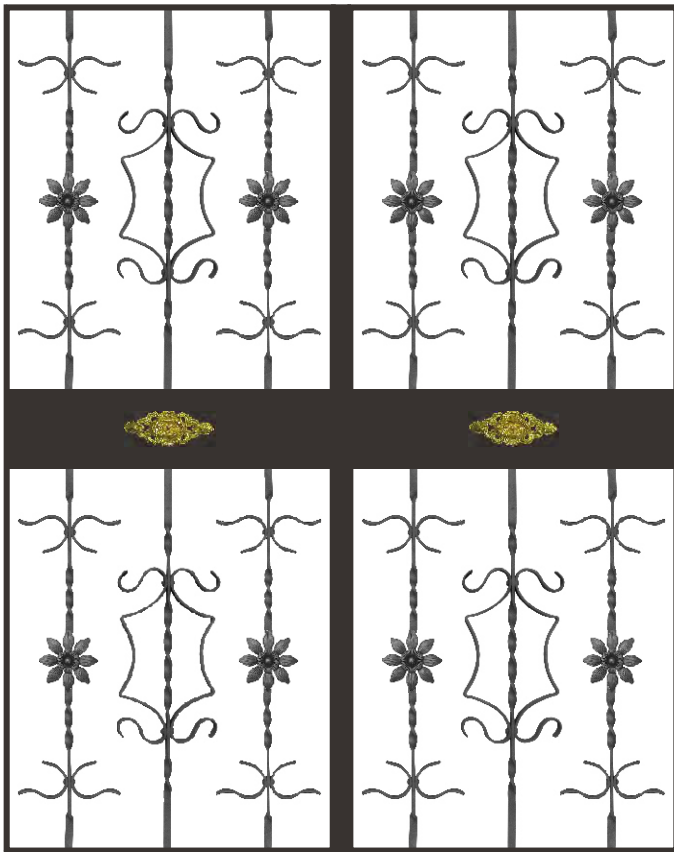

REF.:FBA037;FBA038;VA674

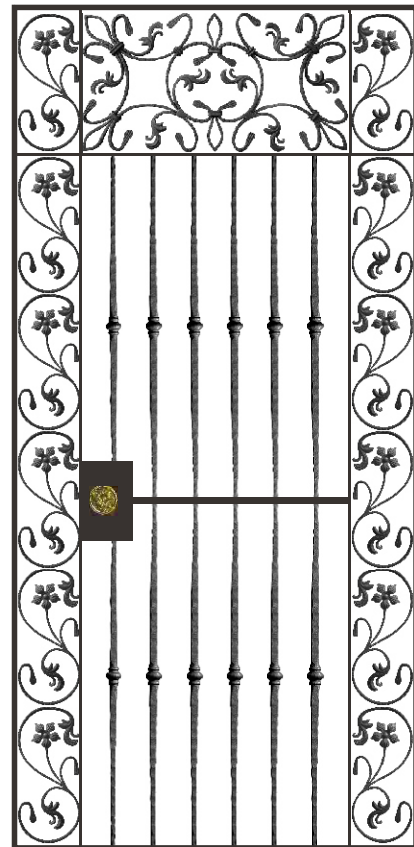

REF.:FBA004A;FAC002;FAC003;FAC004

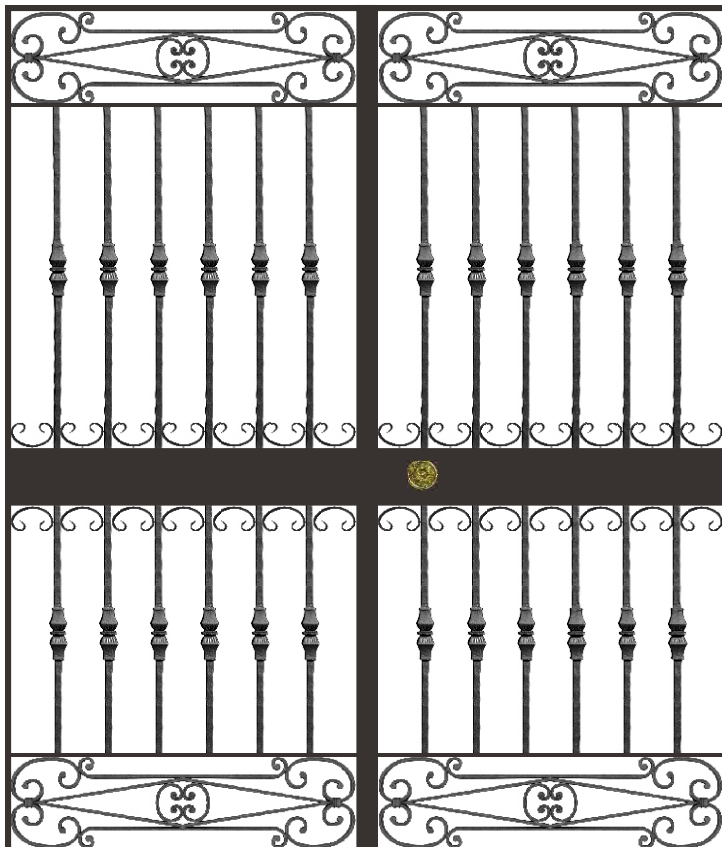

REF.:FBA023A;FBA041;FC004

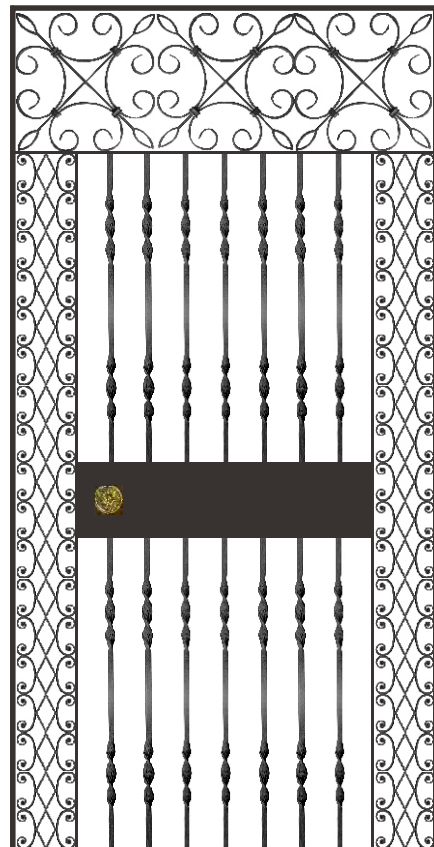

REF.:FBA016B;FAC007;FSO003



REF.:FBA018A;FBA018B;FSO006;FPE001;VA674

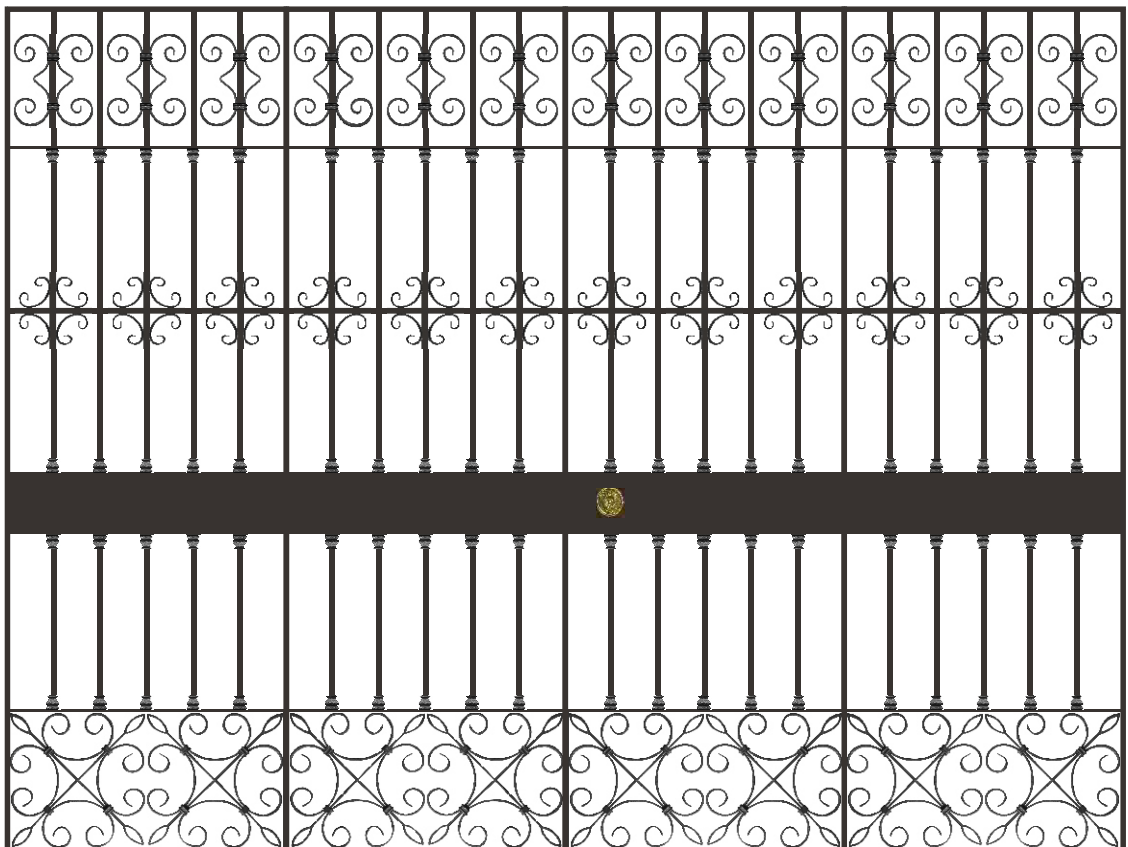

REF.:FAC007;FC004;FE004;MA044



REF.:FRE001;FBA020A;FBA020B;FAC008;FAD019;VA673

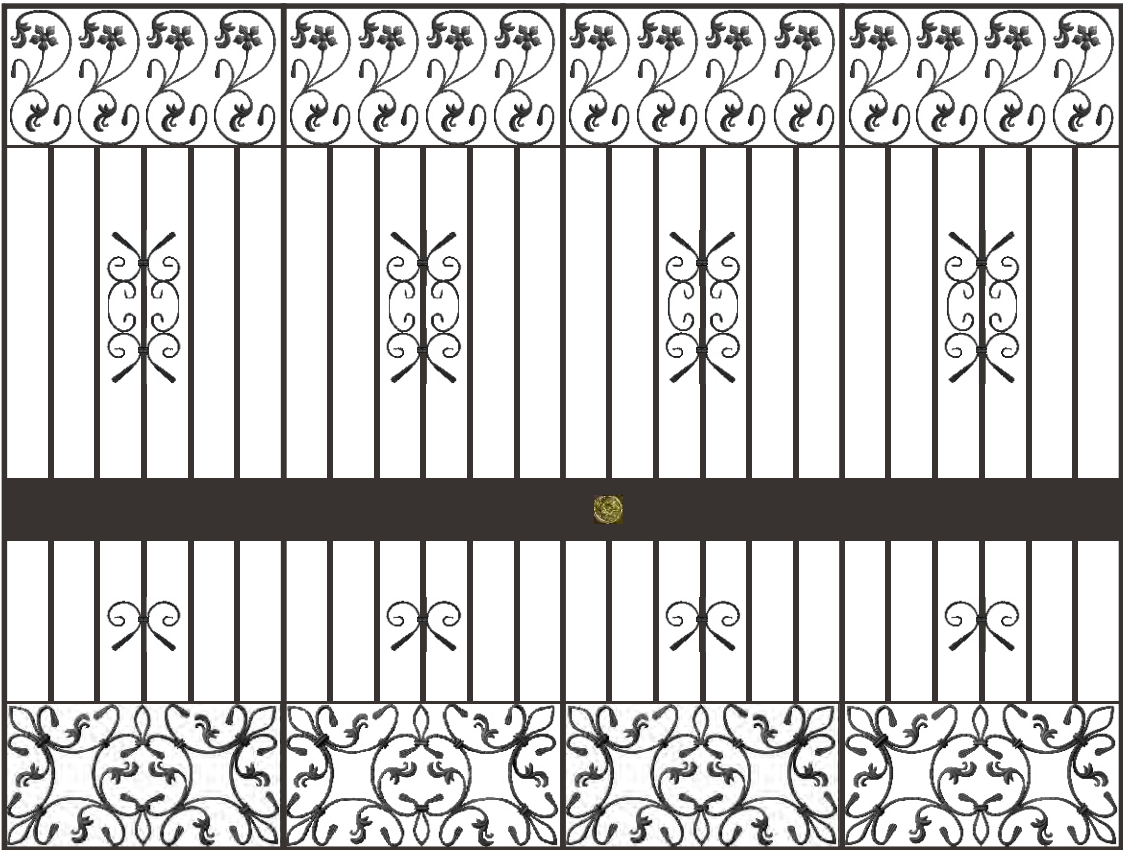

REF.:FAC002;FAC004;FL001;FL002;FC001



CANCELAS / FORJA

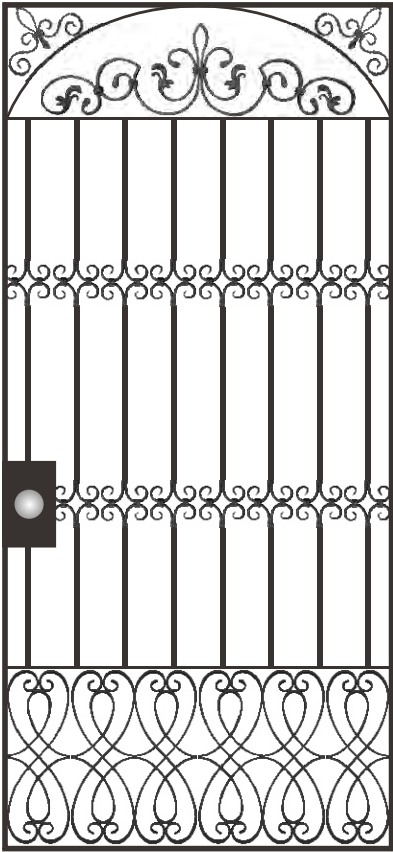

REF.:FAD011;FAD016;FAC010;FPE002

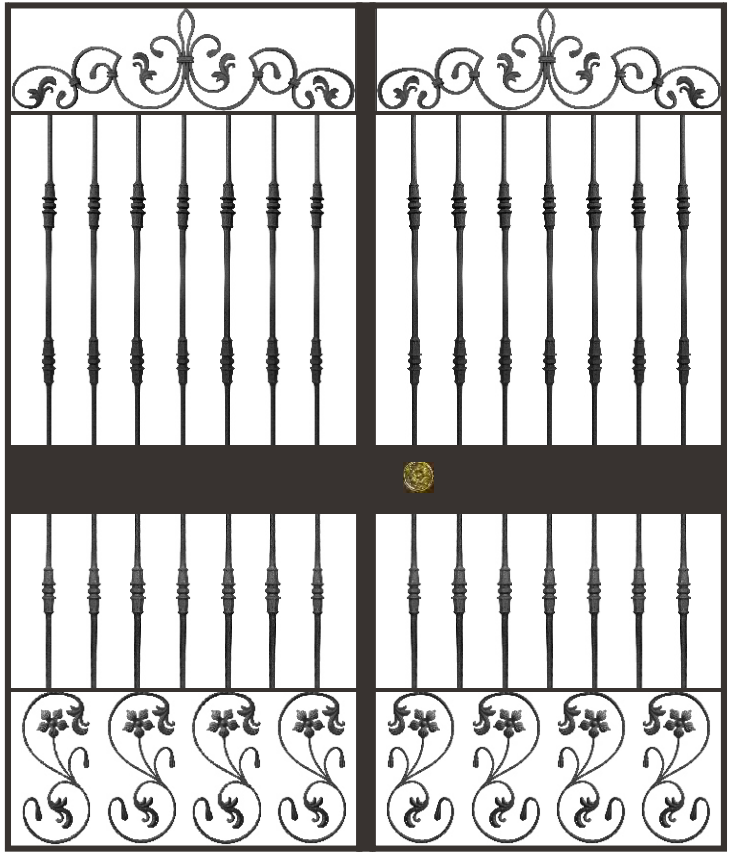

REF.:FBA020A;FBA020B;FAC003;FAC004;FPE002

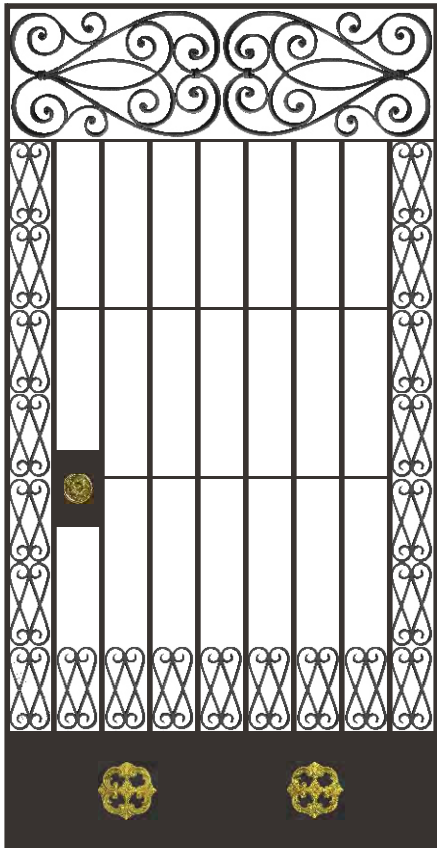

REF.:FAC008;FAD015;VA673

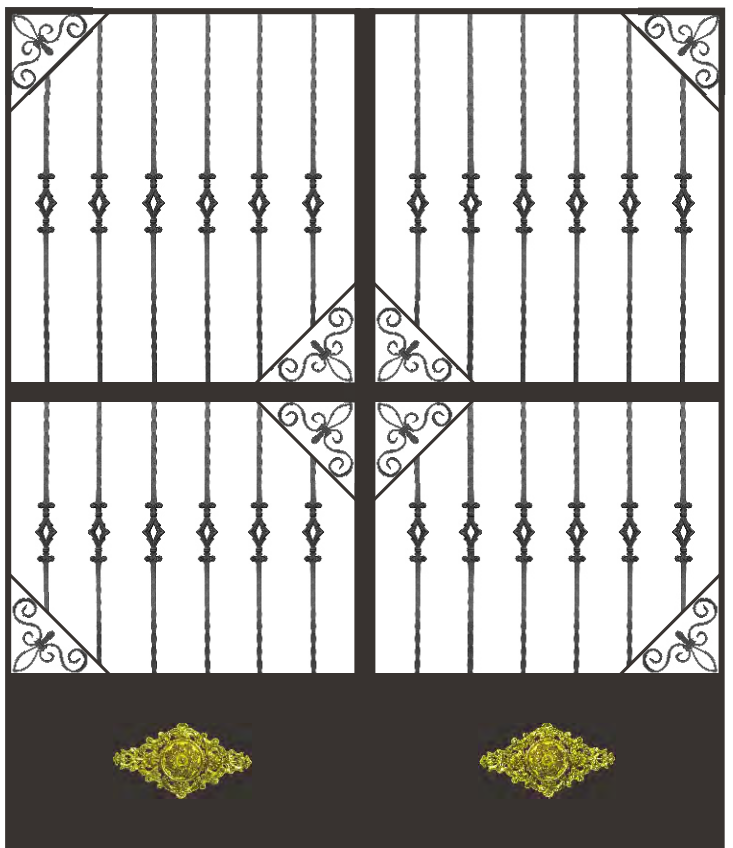

REF.:FBA015A;FAC010;VA677

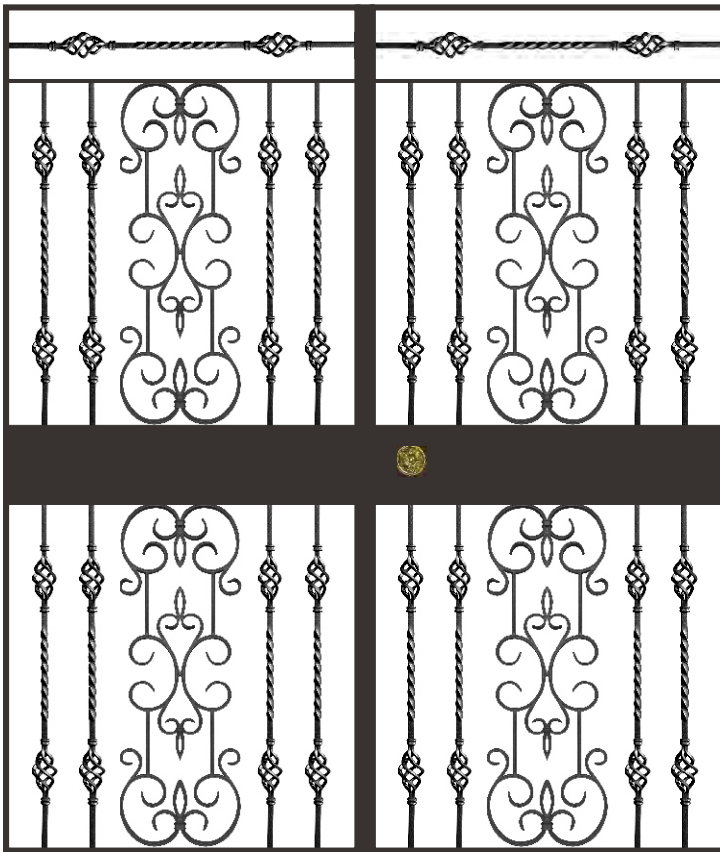

REF.:FBA001B;FBA042

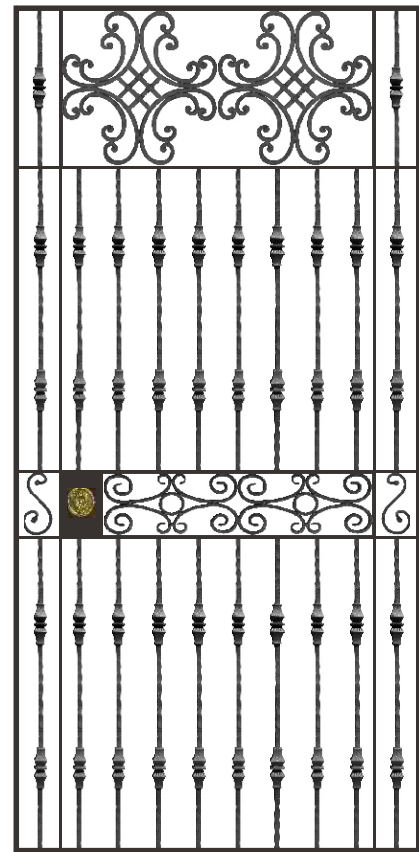

REF.:FBA023B;FAD025;FSO007;FS002

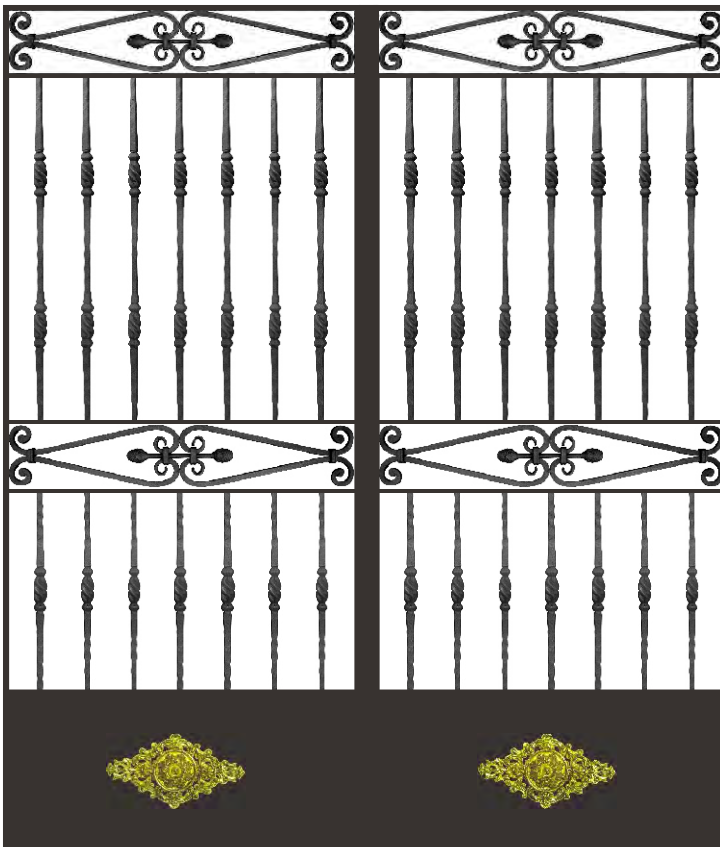

REF.:FBA013A;FBA013B;FBA043;VA677

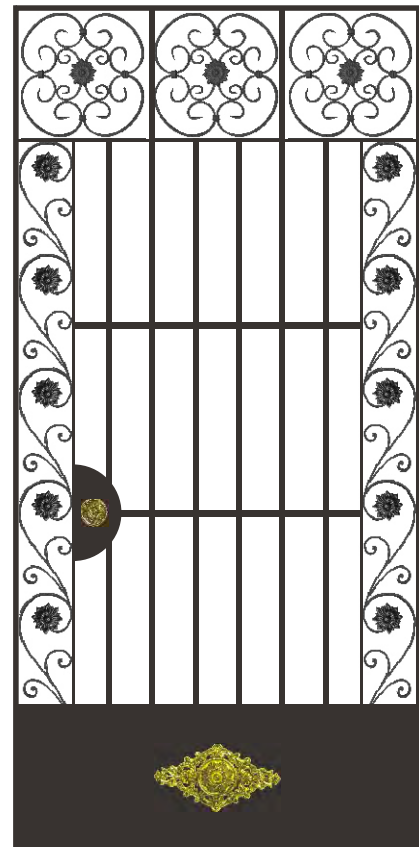

REF.:FAD018;FAD024;FBP001;VA677



REF.:FAD037;FAD038;FSO011;FPE005;VA070

REF.:FAD041;FAD042;FLA015

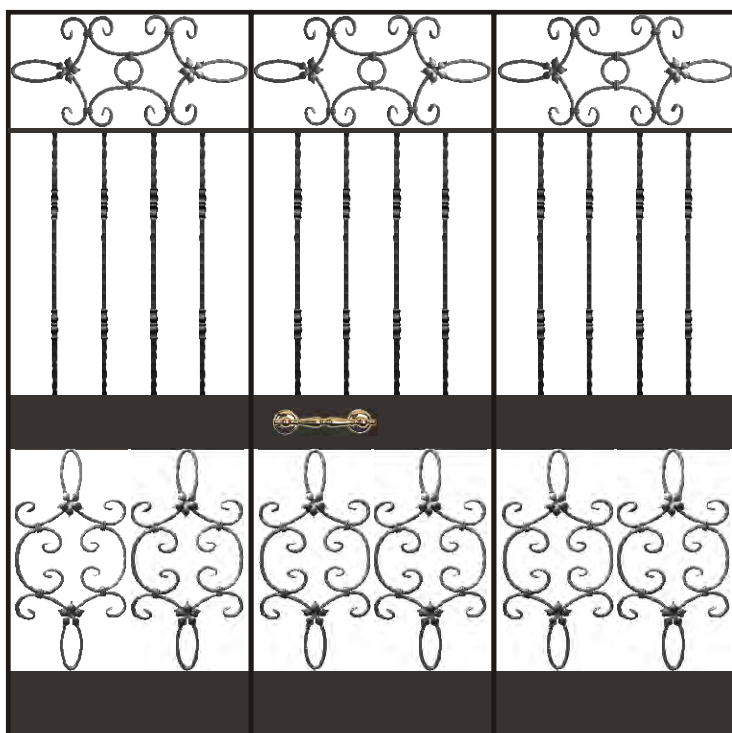

REF.:FAD032;FAD033;FBA012B

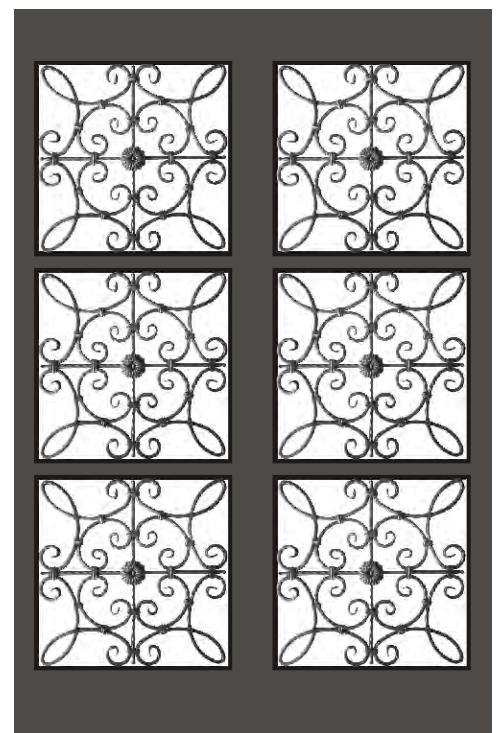

REF.:FAD031

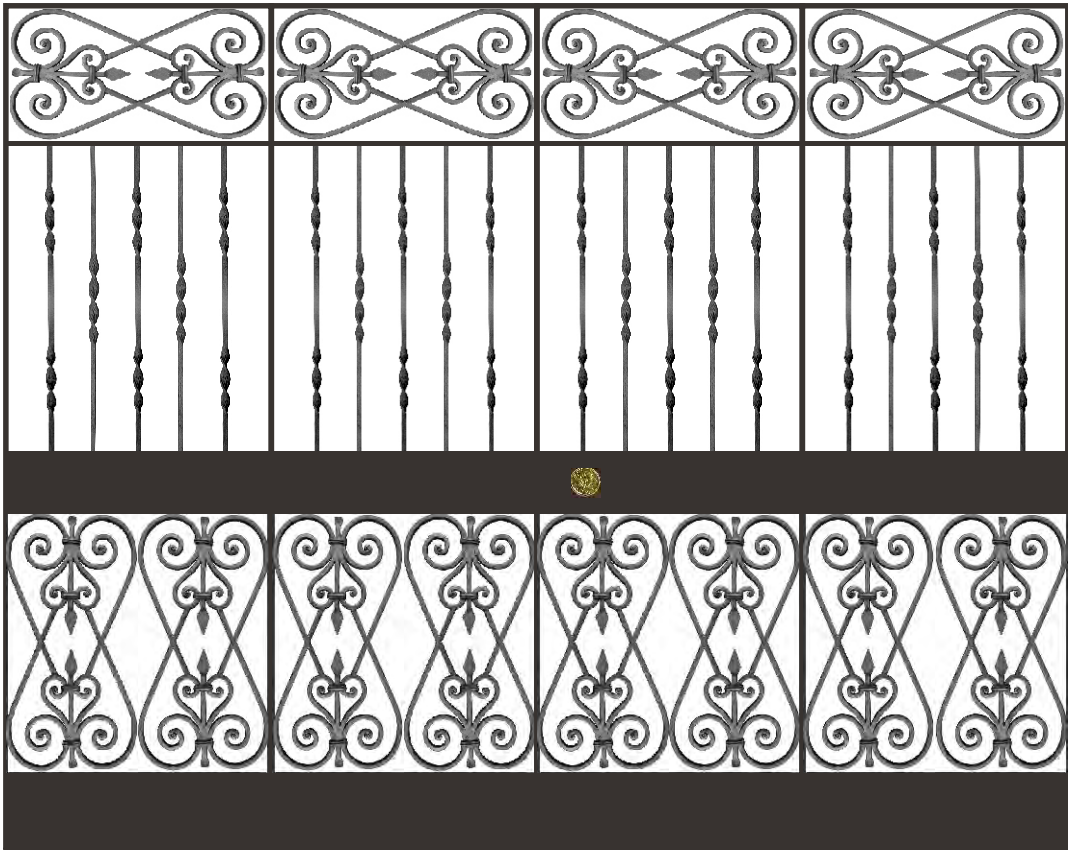

REF.:FAC012;FBA016A;FBA016B

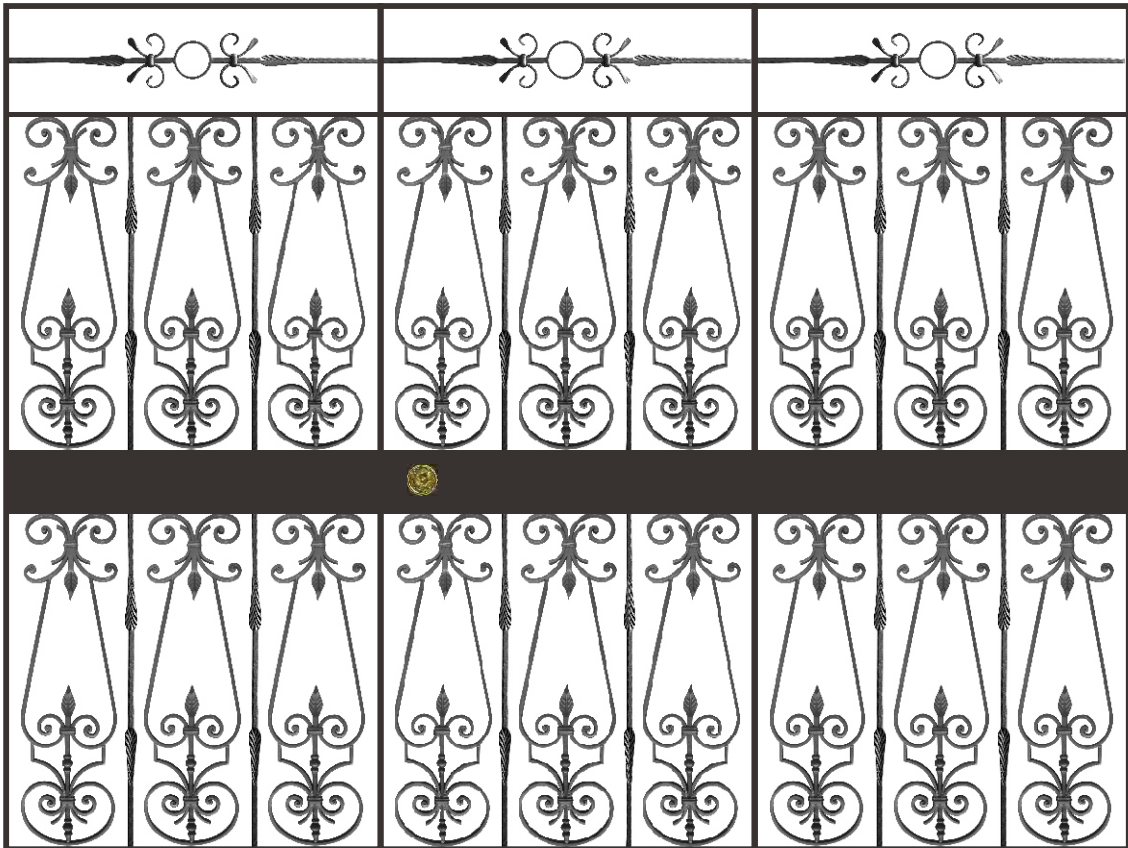

REF.:FBA002B;FBA072;FBA086

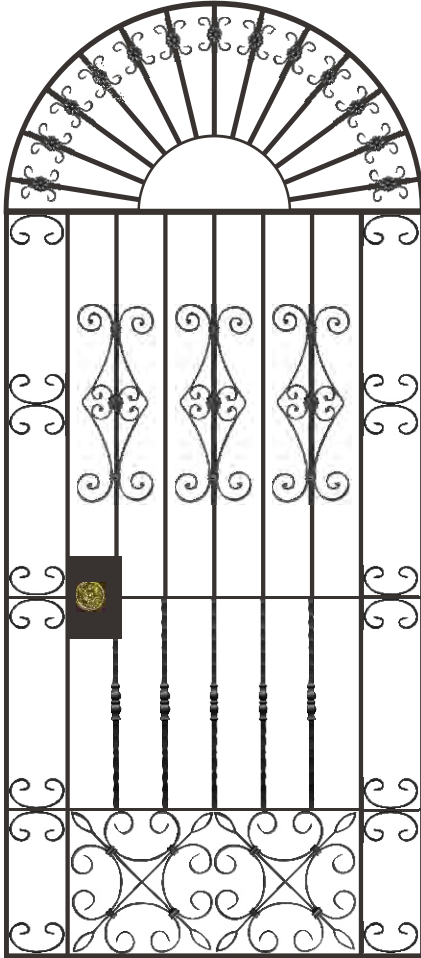

REFERENCIA
FBA012A;FBA039
FC001;FAC007
FAD002

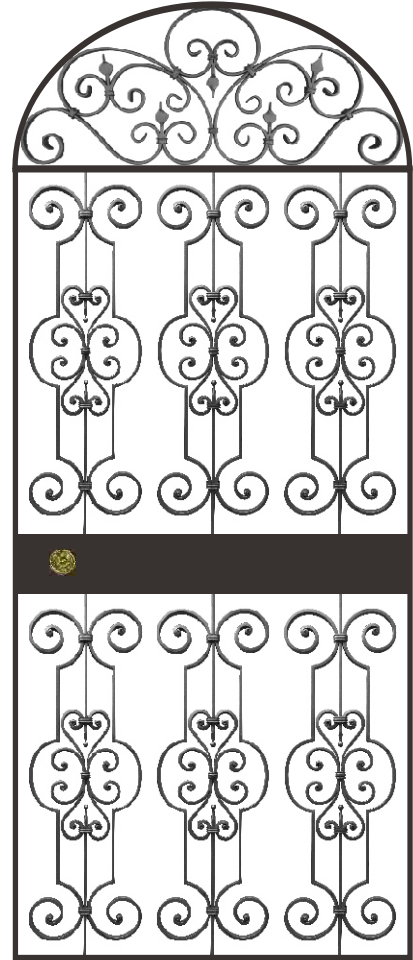

REFERENCIA
FAC011
FBA078

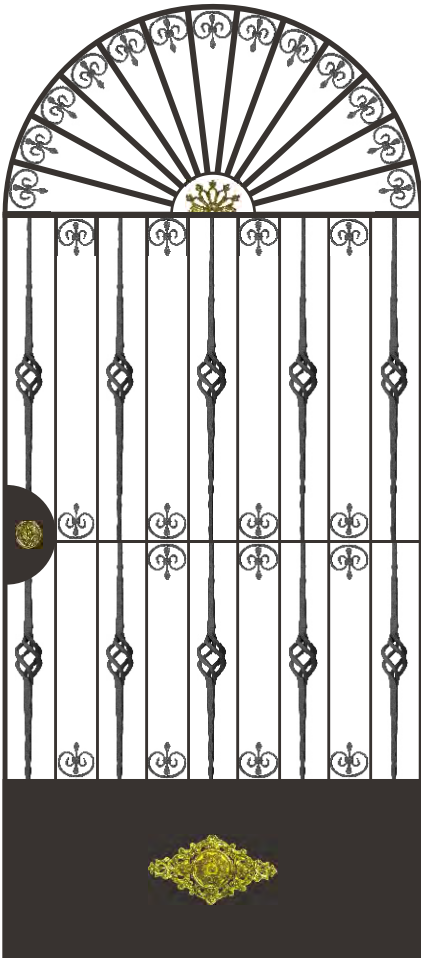

REFERENCIA
FBA019A;FLA019
AC632;VA677

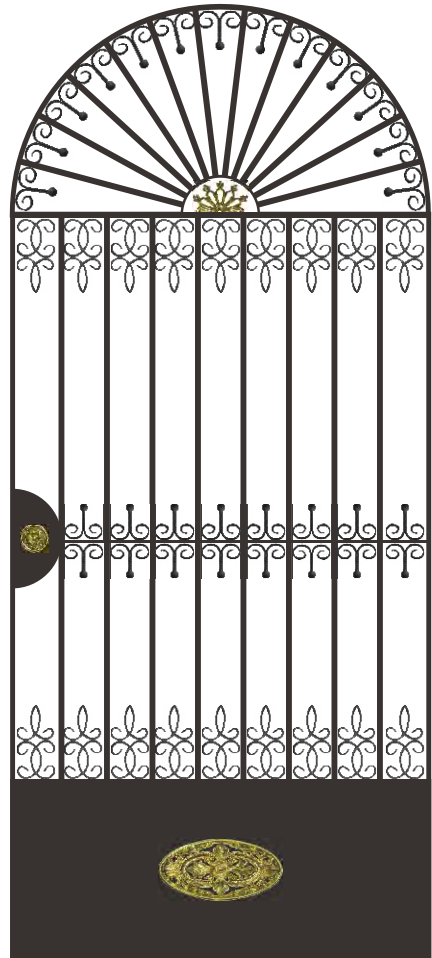

REFERENCIA
FAD004;FLA020
AC632;VA688

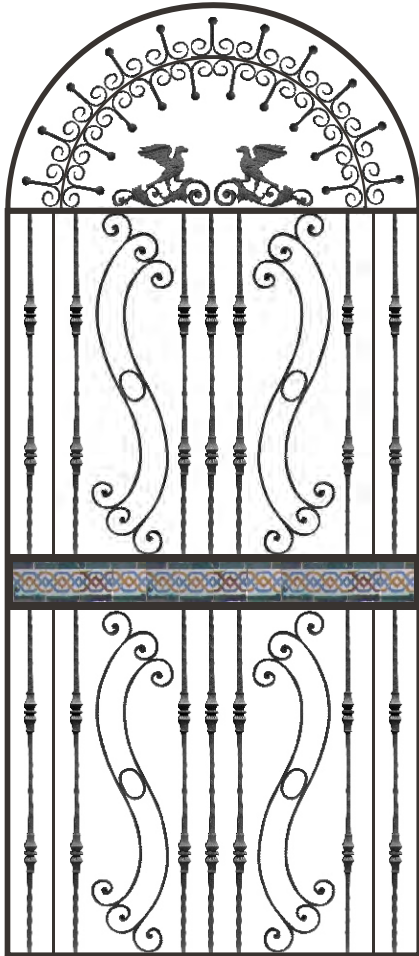

REFERENCIA
FBA045E;FBA023B
FLA020;AC024

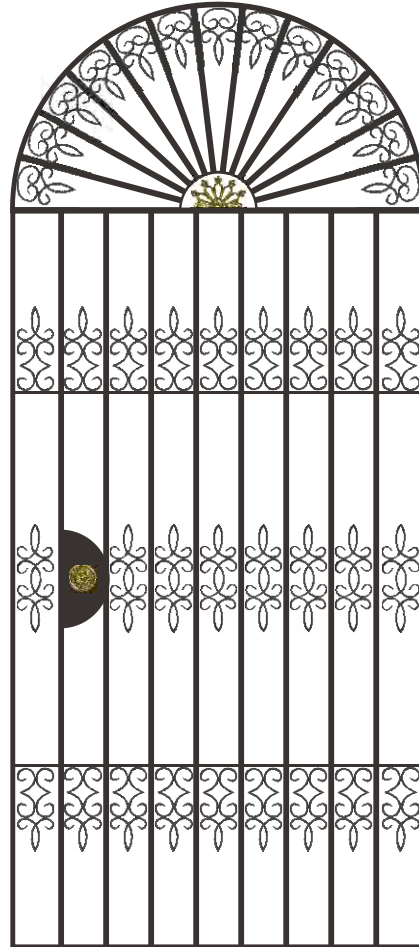

REFERENCIA
FAD003;FAD005
FAD006;AC632

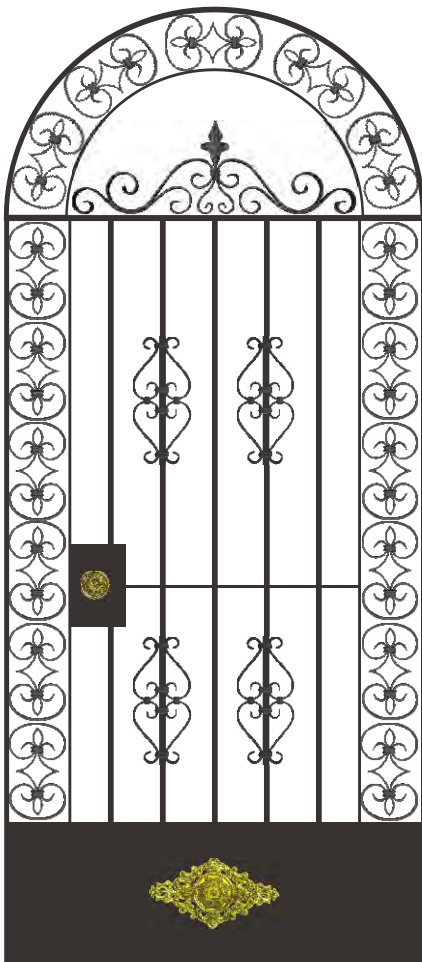

REFERENCIA
FAD010;FPE003
FSO005;VA677

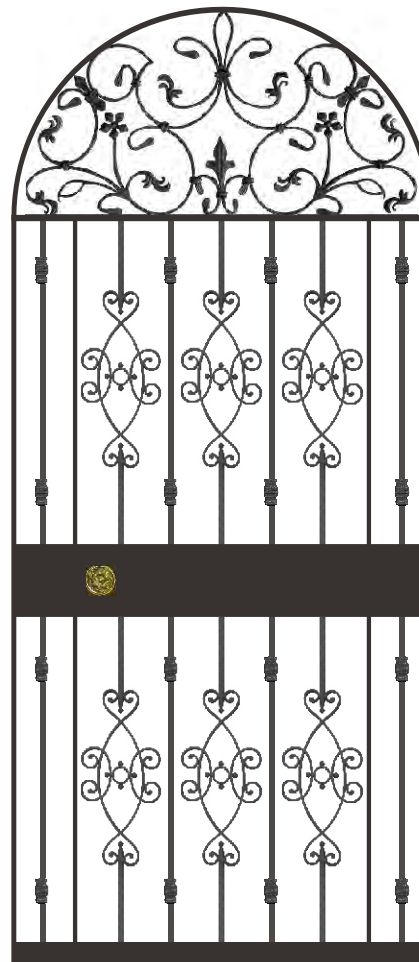

REFERENCIA
FBA036;FAC001
FMA055

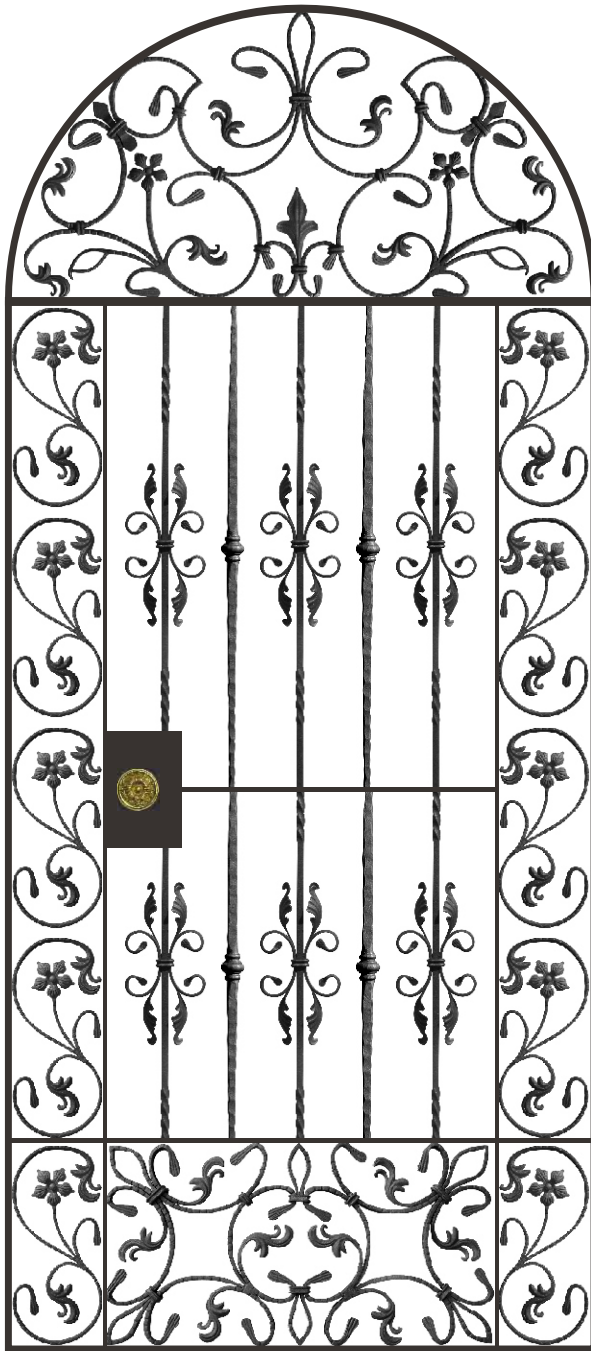

REFERENCIA

FBA004A
FBA007/16
FAC001;FAC002
FAC003;FAC004

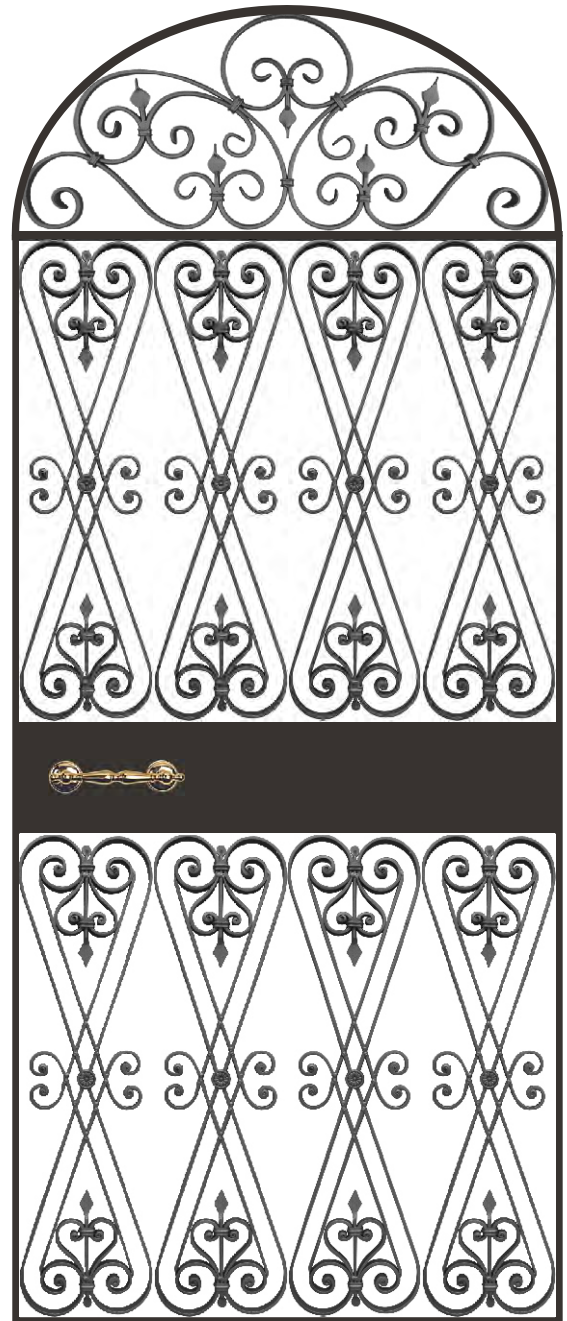

REFERENCIA

FAC011
FBA087
TI606